

A

S620/SZU

VABRES

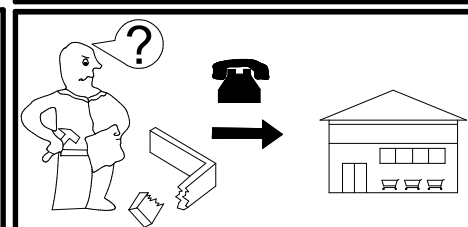

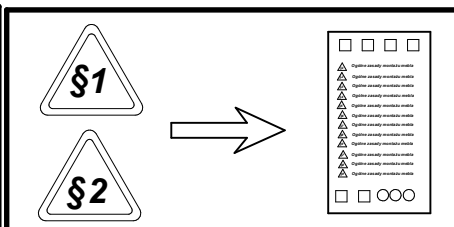
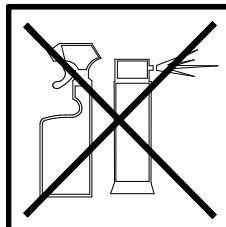
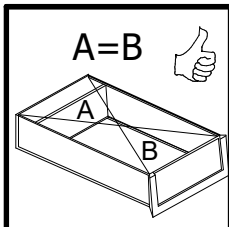
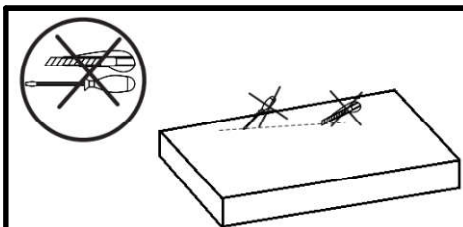
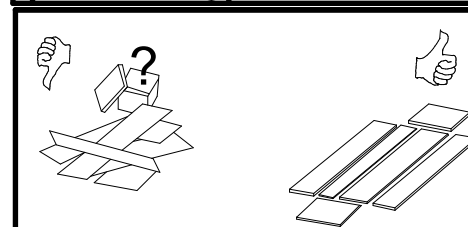
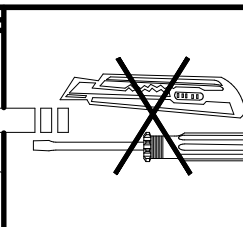
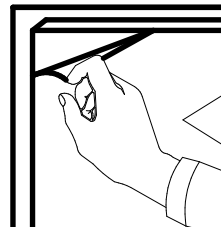
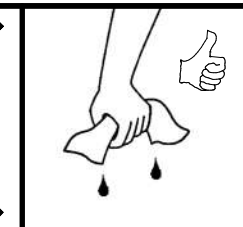
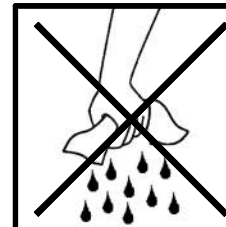
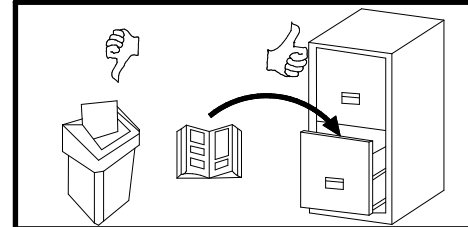
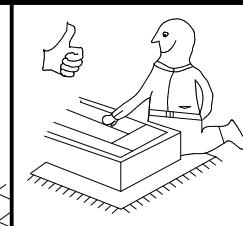
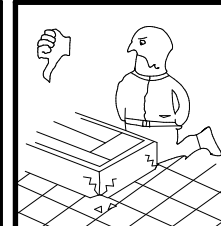
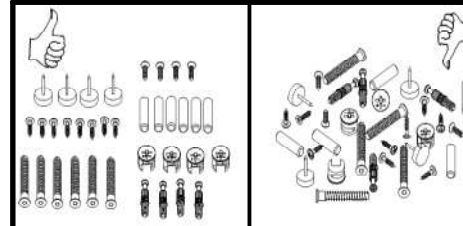
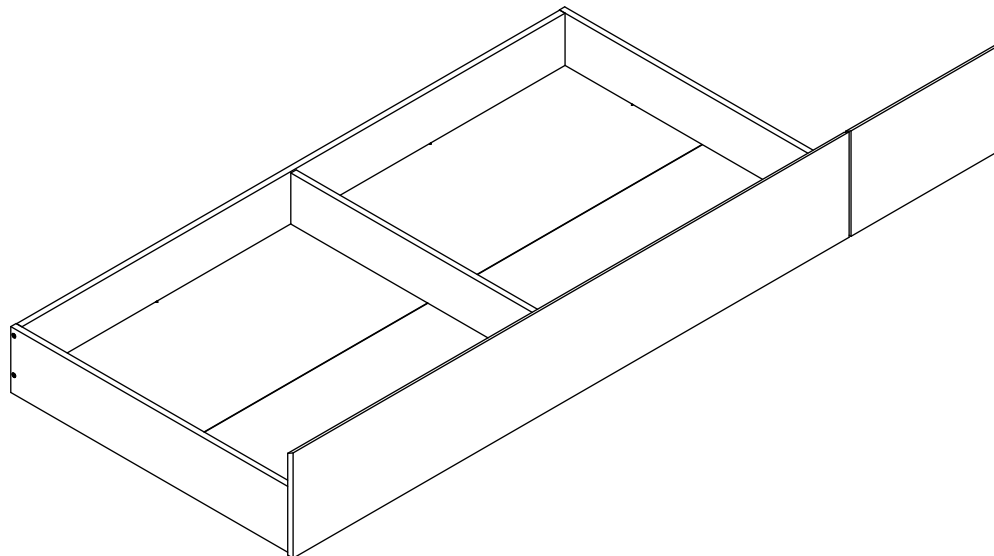
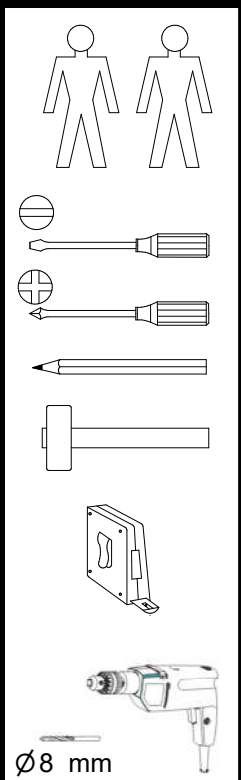

∅ 8 mm

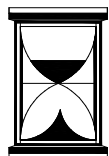

20 min

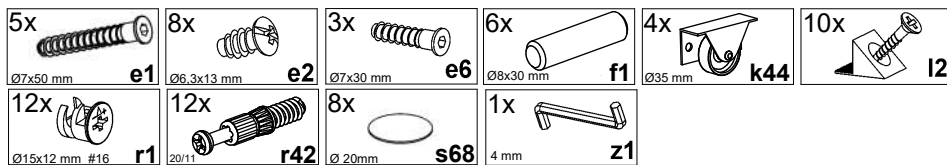



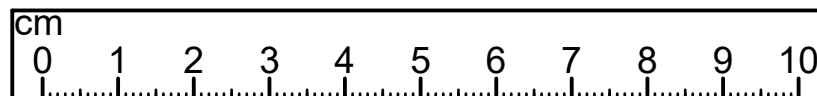

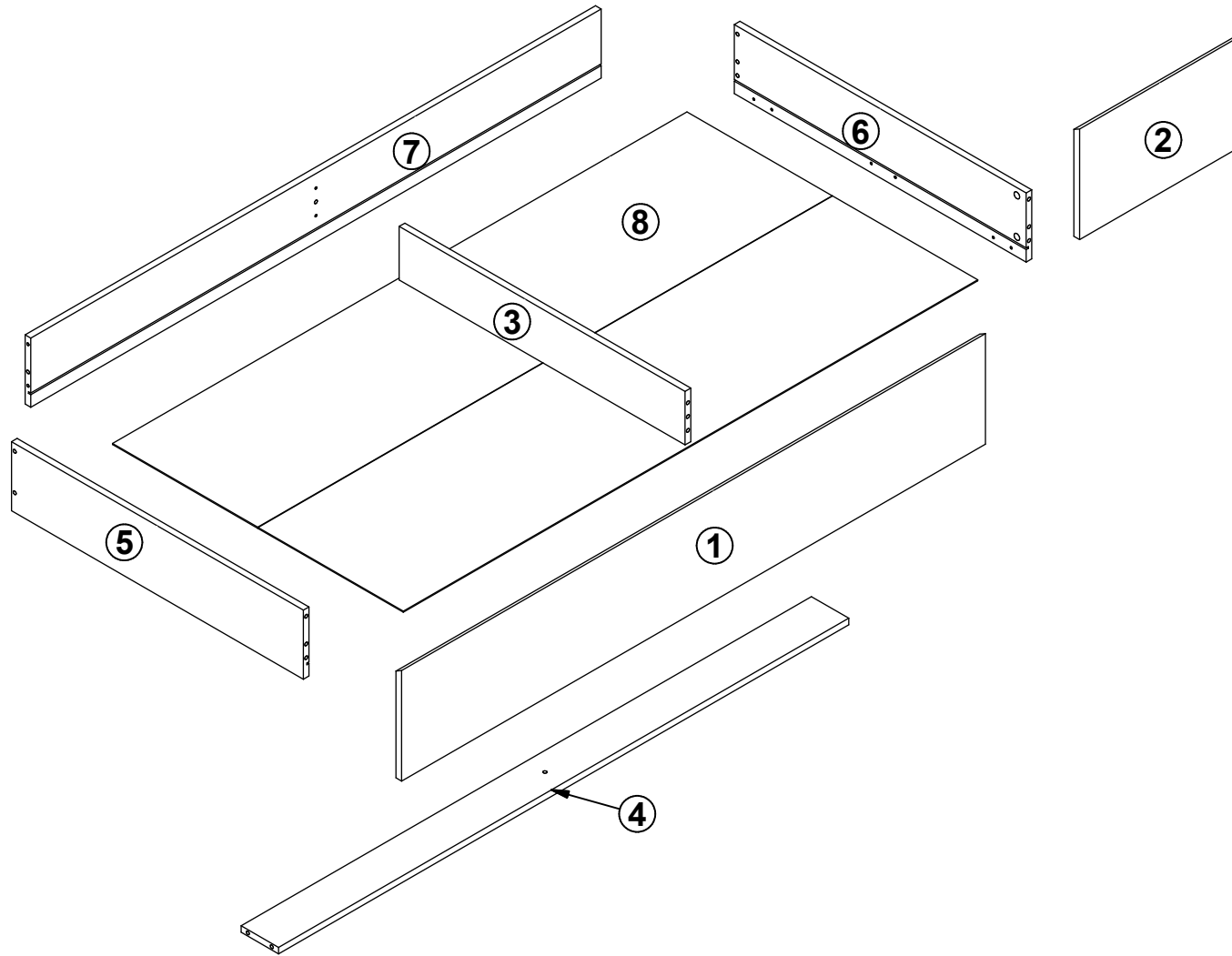
A	B1	B2	C1	C2	C3	D
1	S620-0028	-.5	1560	256	15	1/1
2	S620-4007	-.5	430	256	15	1/1
3	ZZ1-4008	-.2	764	124	15	1/1
4	ZZ1-4010		1524	100	15	1/1
5	ZZ1-5001	-.1	780	160	15	1/1
6	ZZ1-5002	-.1	780	160	15	1/1
7	ZZ1-5019	-01	1524	160	15	1/1
8	ZZ1-9308		1535	777	2,5	1/1

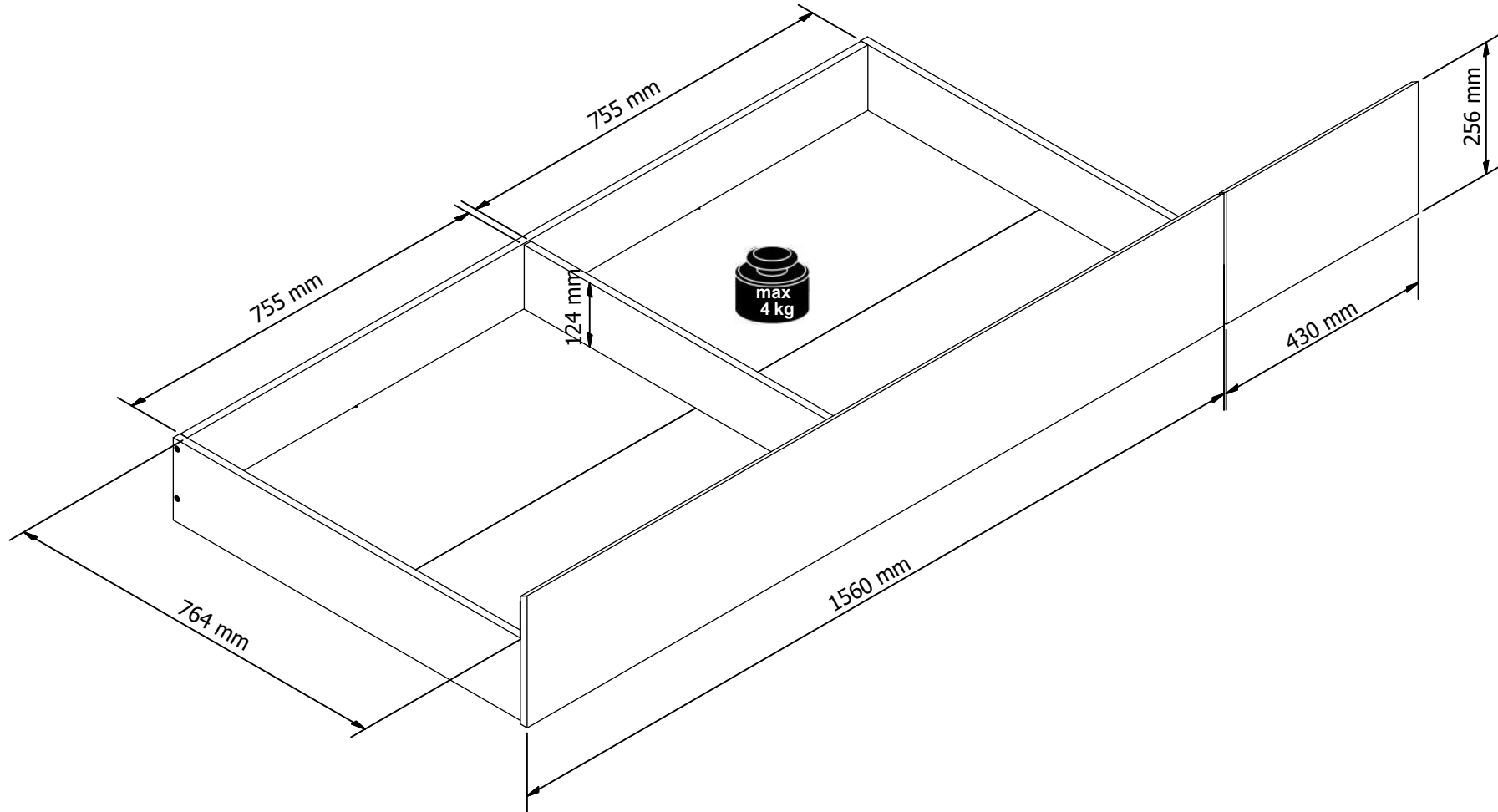





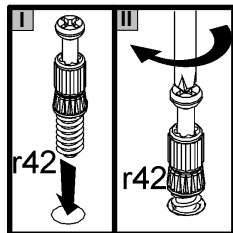
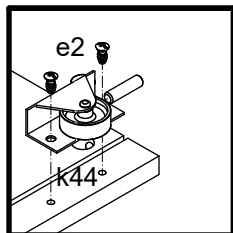
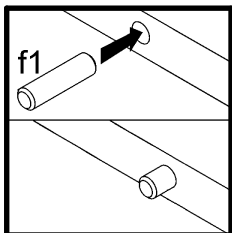
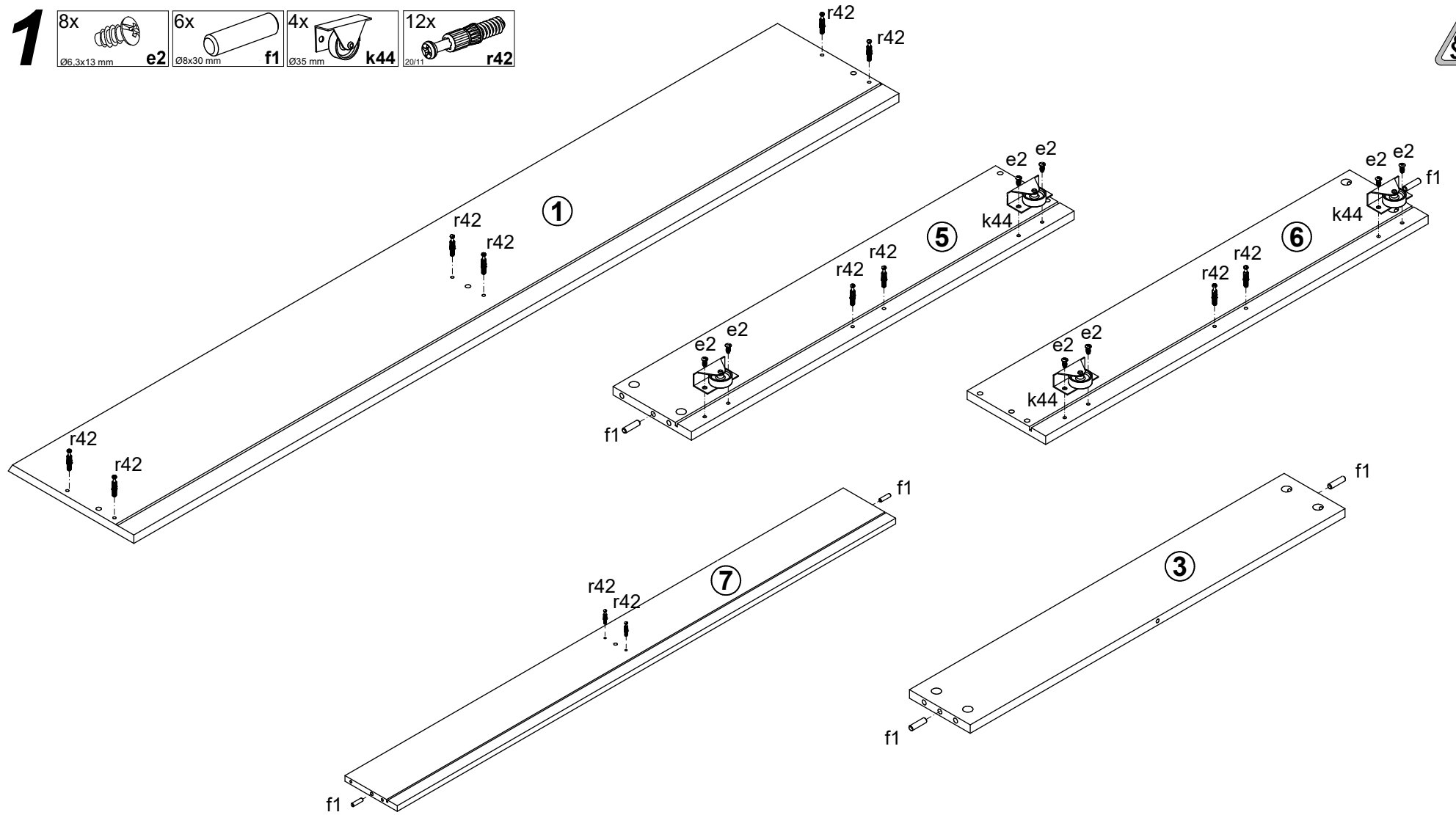

- 1**
- 8x  e2 $\varnothing 6,3 \times 13 \text{ mm}$
 - 6x  f1 $\varnothing 8 \times 30 \text{ mm}$
 - 4x  k44 $\varnothing 35 \text{ mm}$
 - 12x  r42 20/11

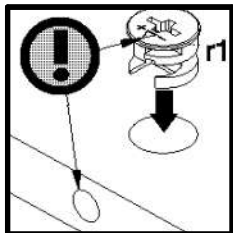
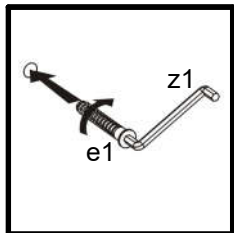
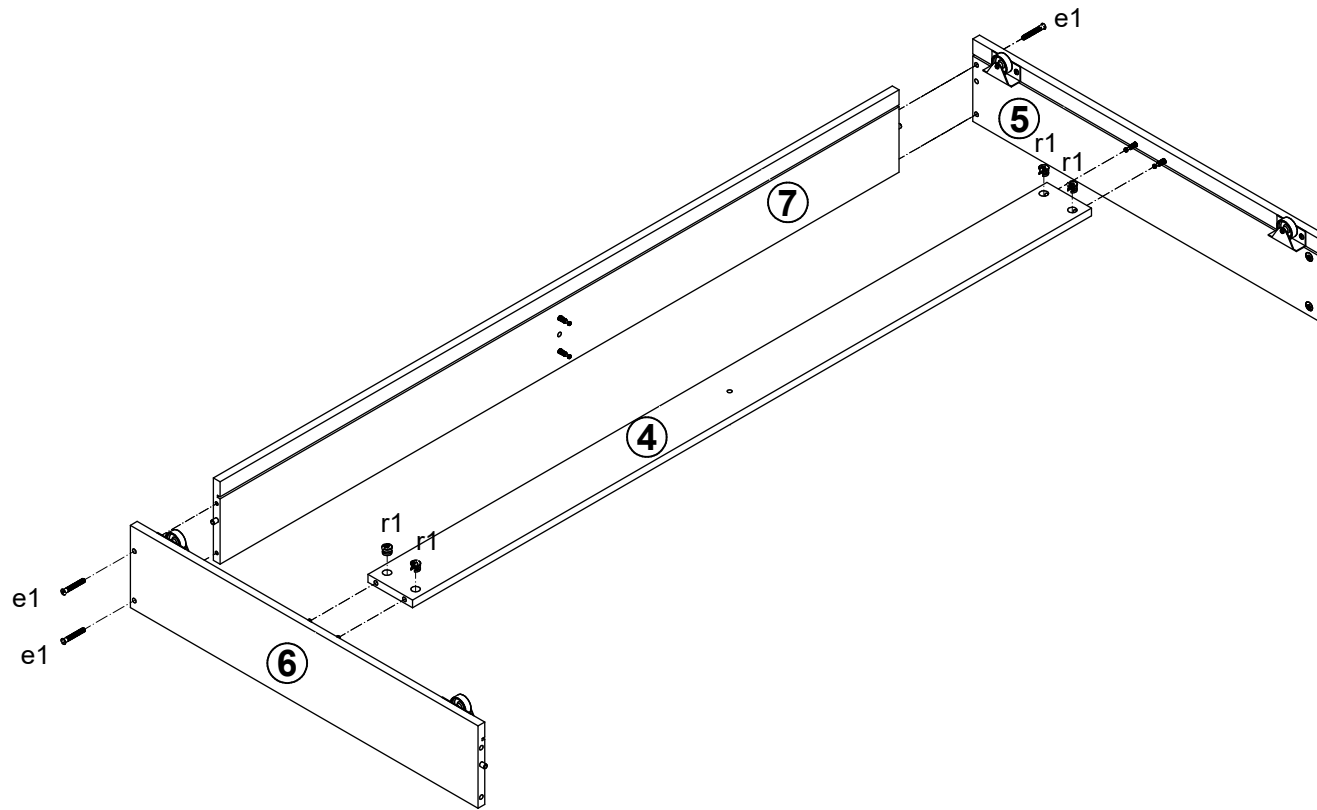
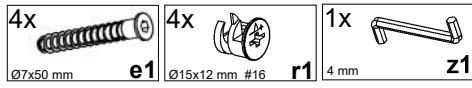

2



3 8x  Ø15x12 mm #16 r1



4 8x  Ø 20mm s68

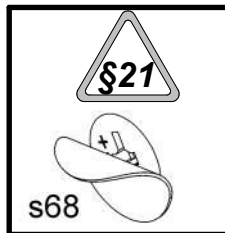
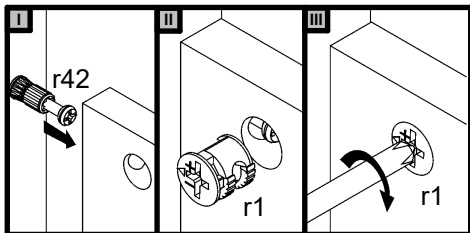
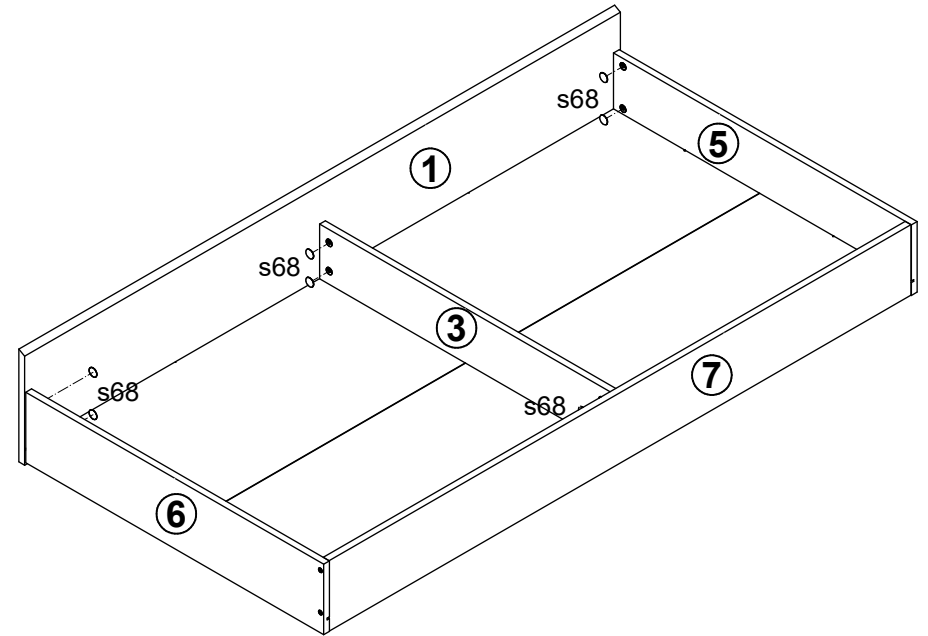
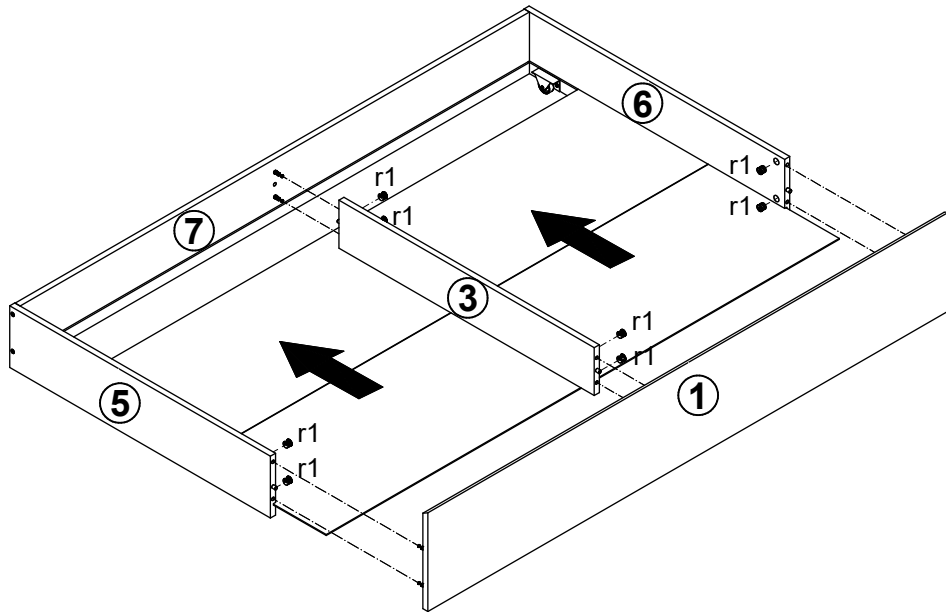

5

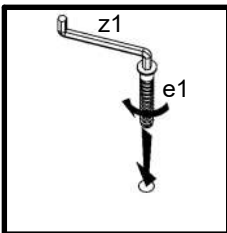
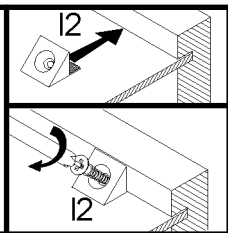
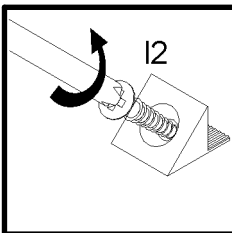
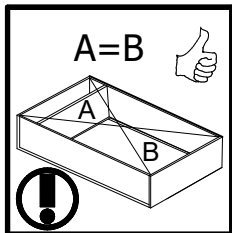
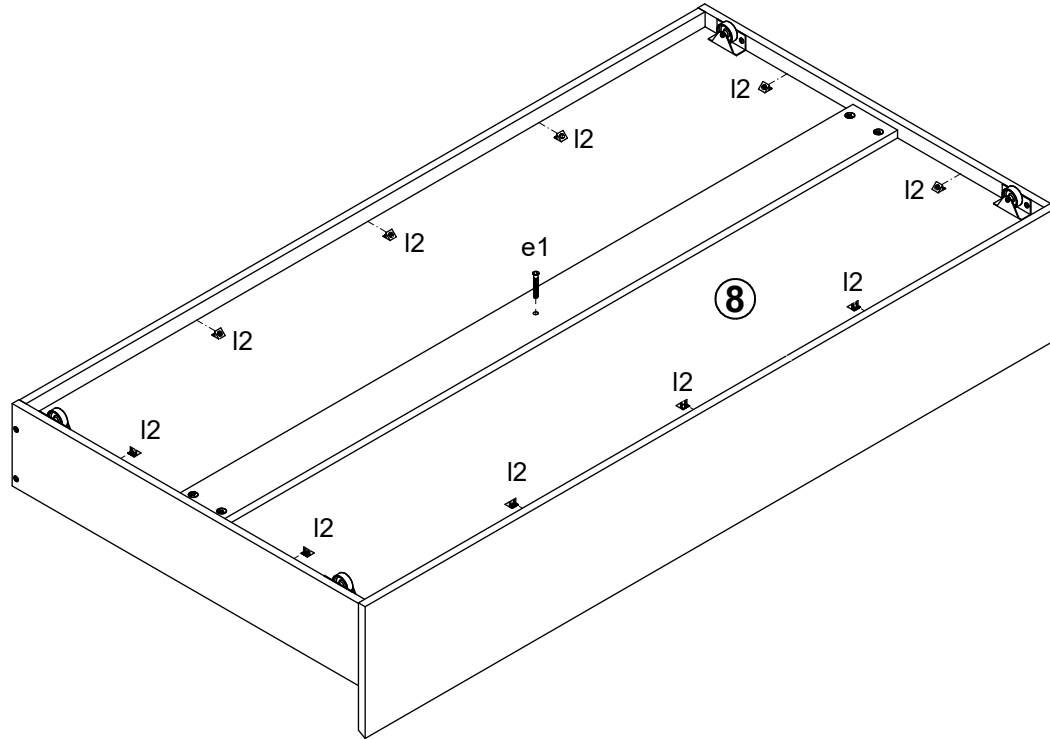
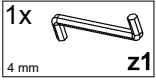
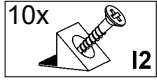

6A

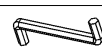
- 3x  e6
Ø7x30 mm
- 1x  z1
4 mm

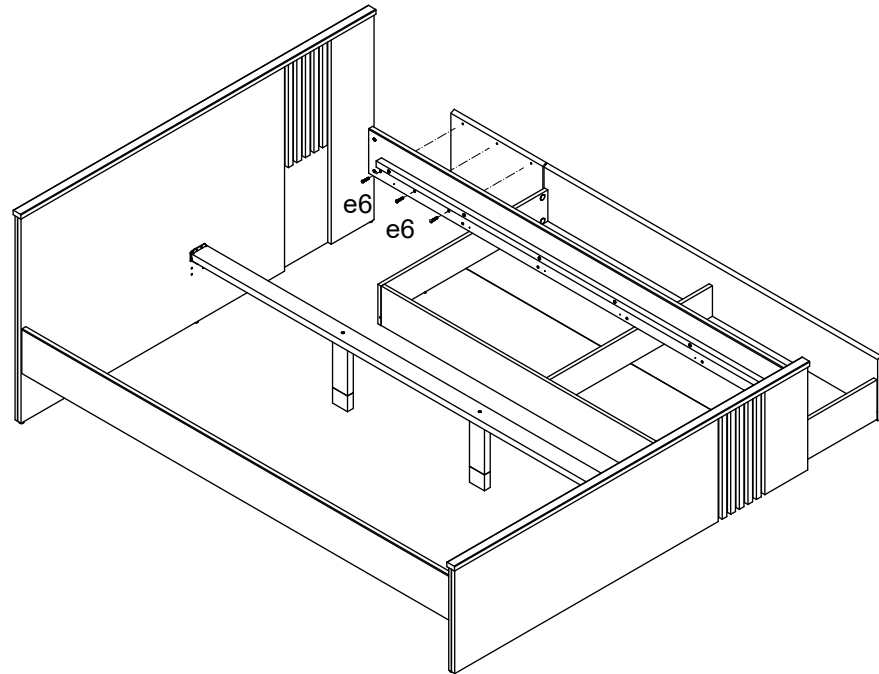

6B

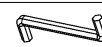
- 3x  e6
Ø7x30 mm
- 1x  z1
4 mm

