

A**S620-SZF3D****VABRES**

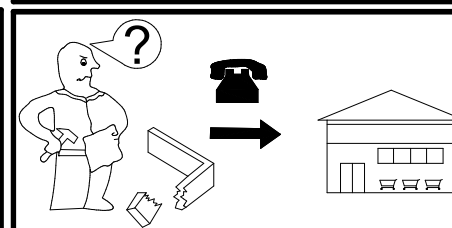

50 min

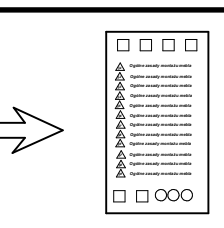

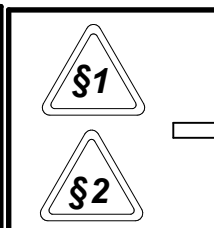
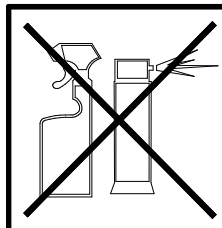
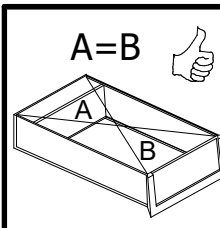
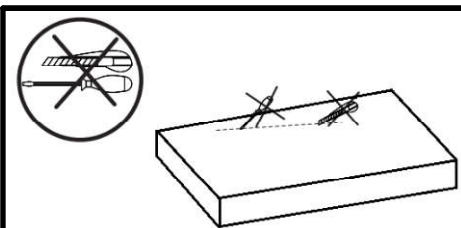
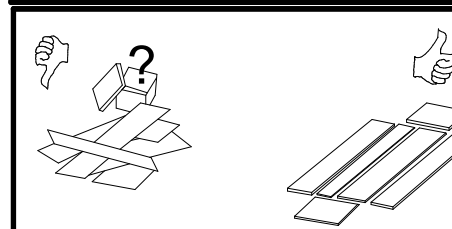
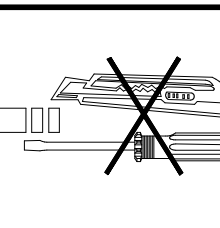
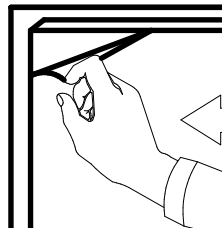
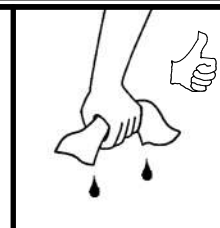
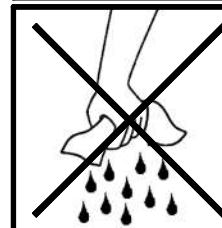
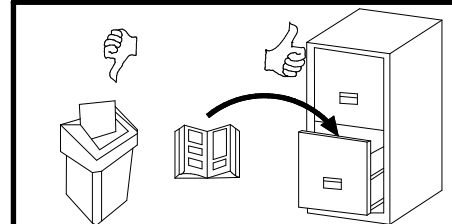
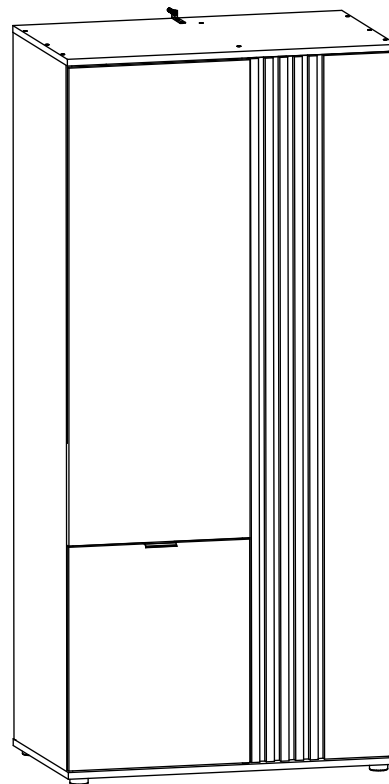
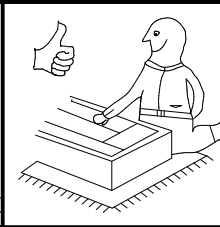
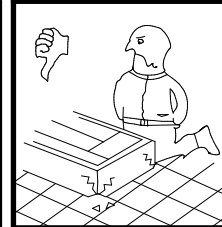
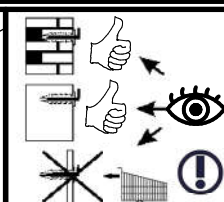
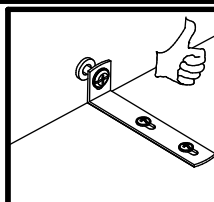
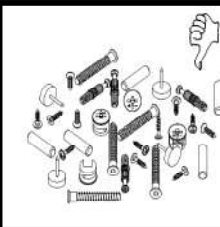
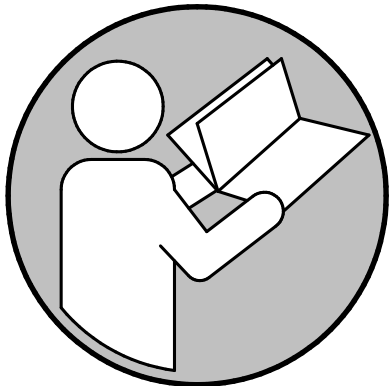
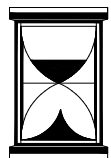
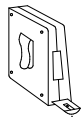
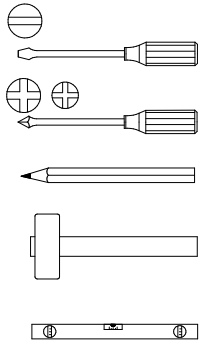
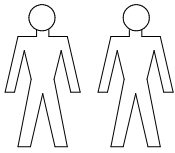
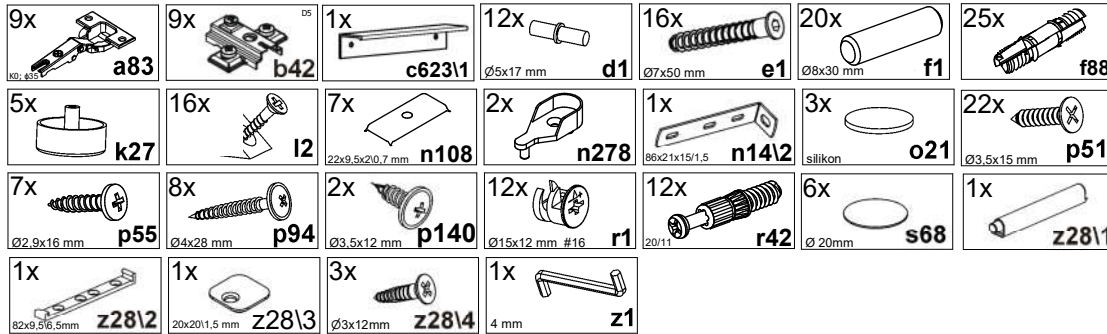

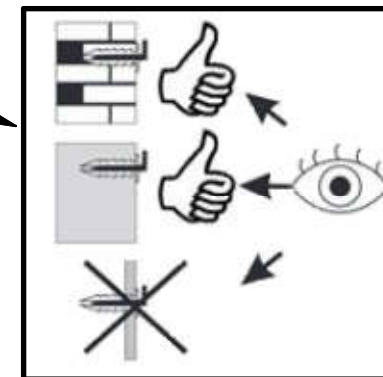
A	B1	B2	C1	C2	C3	D
1	S620-0014	-5	600	496	16	1/3
2	S620-0017	-5	1888	196	16	1/3
3	S620-0020	-5	1284	496	16	1/3
4	S620-1017	-5	1896	540	16	2/3
5	S620-1018	-5	1896	540	16	2/3
6	S620-1019	-6	1896	520	16	2/3
7	S620-2009	-5	901	558	18	3/3
8	S620-2010	-5	901	558	18	3/3
9	S620-3010	-4	466	516	16	3/3
10	S620-3011	-4	385	503	16	3/3
11	S620-3012	-4	466	503	16	3/3
12	S620-5060	-6	1888	22	16	1/3
13	S620-7005	-6	1888	250	16	1/3
14	S620-9007	-5	1906	398	2,5	1/3
15	S620-9305	-5	1906	479	2,5	1/3
16	dr-378	-	378	22	15	3/3

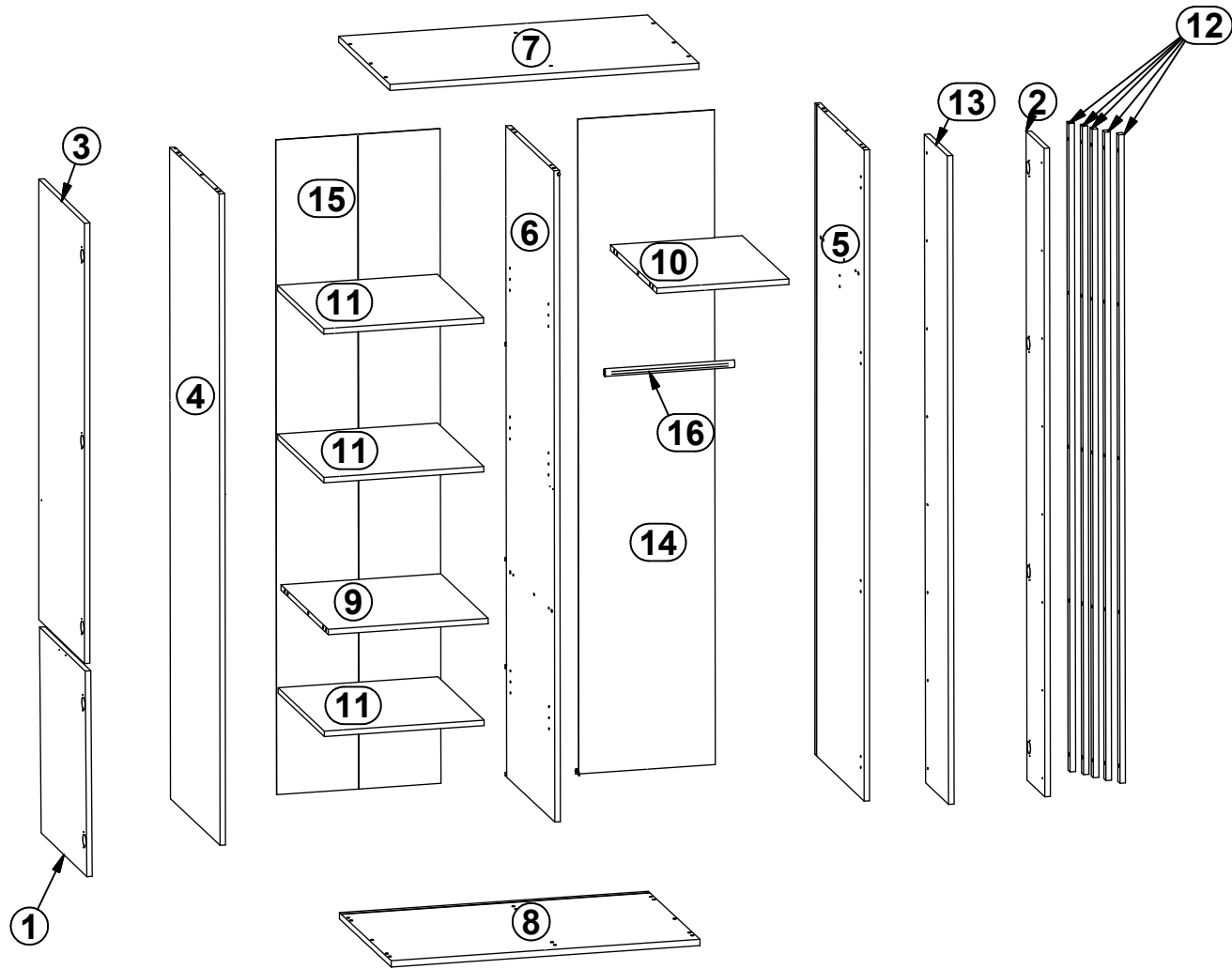

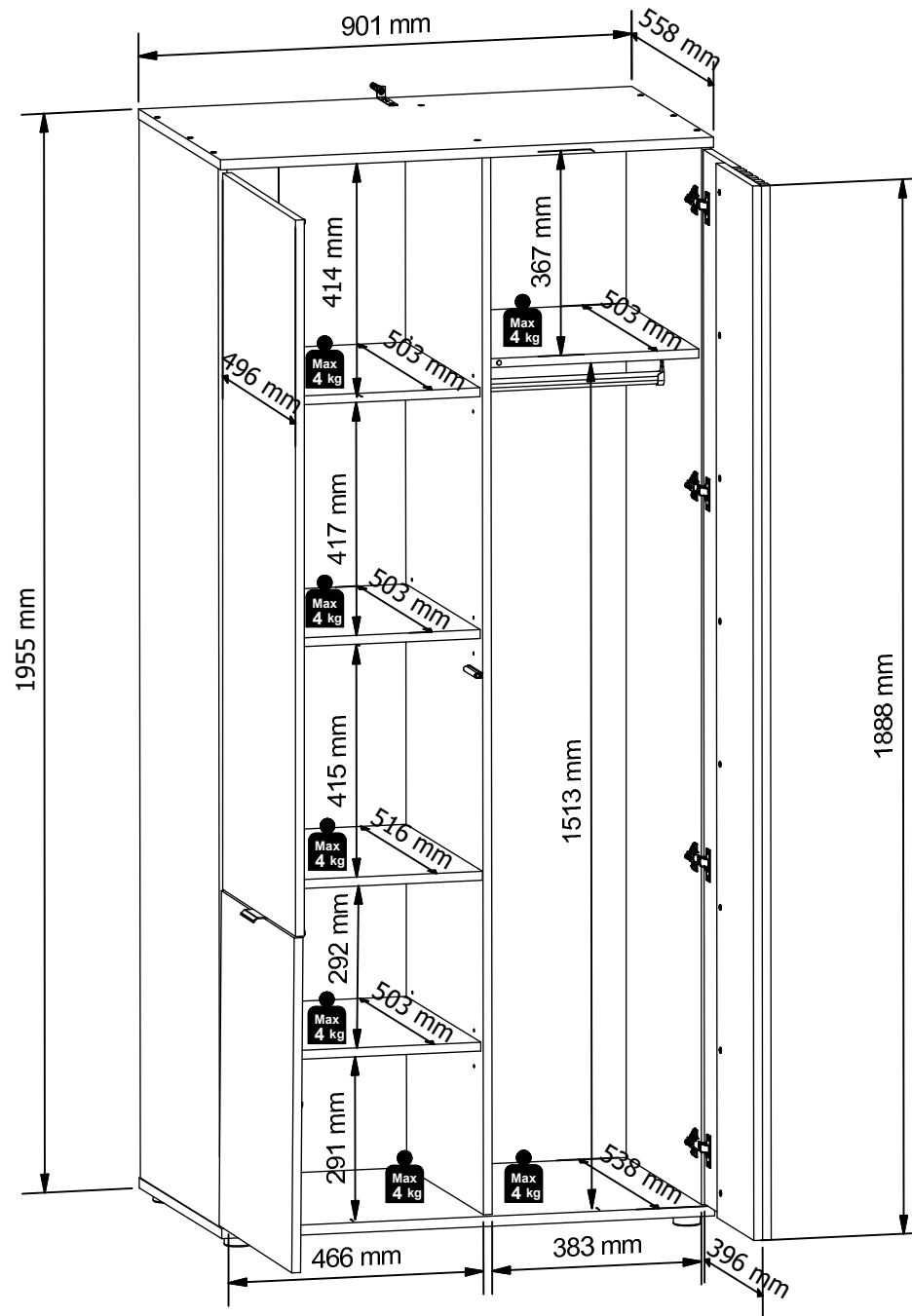

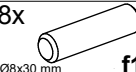

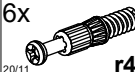
- 1 9x  b42
- 8x  f1
- 1x  n278
- 1x  p51
- 6x  r42

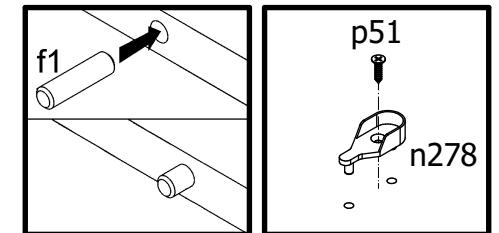
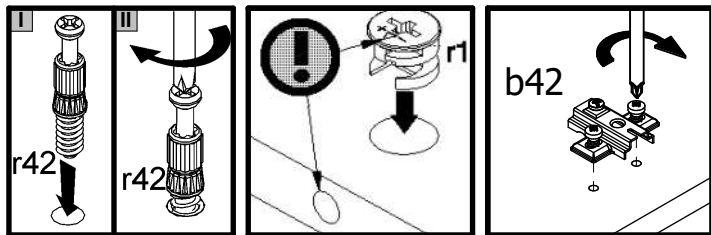
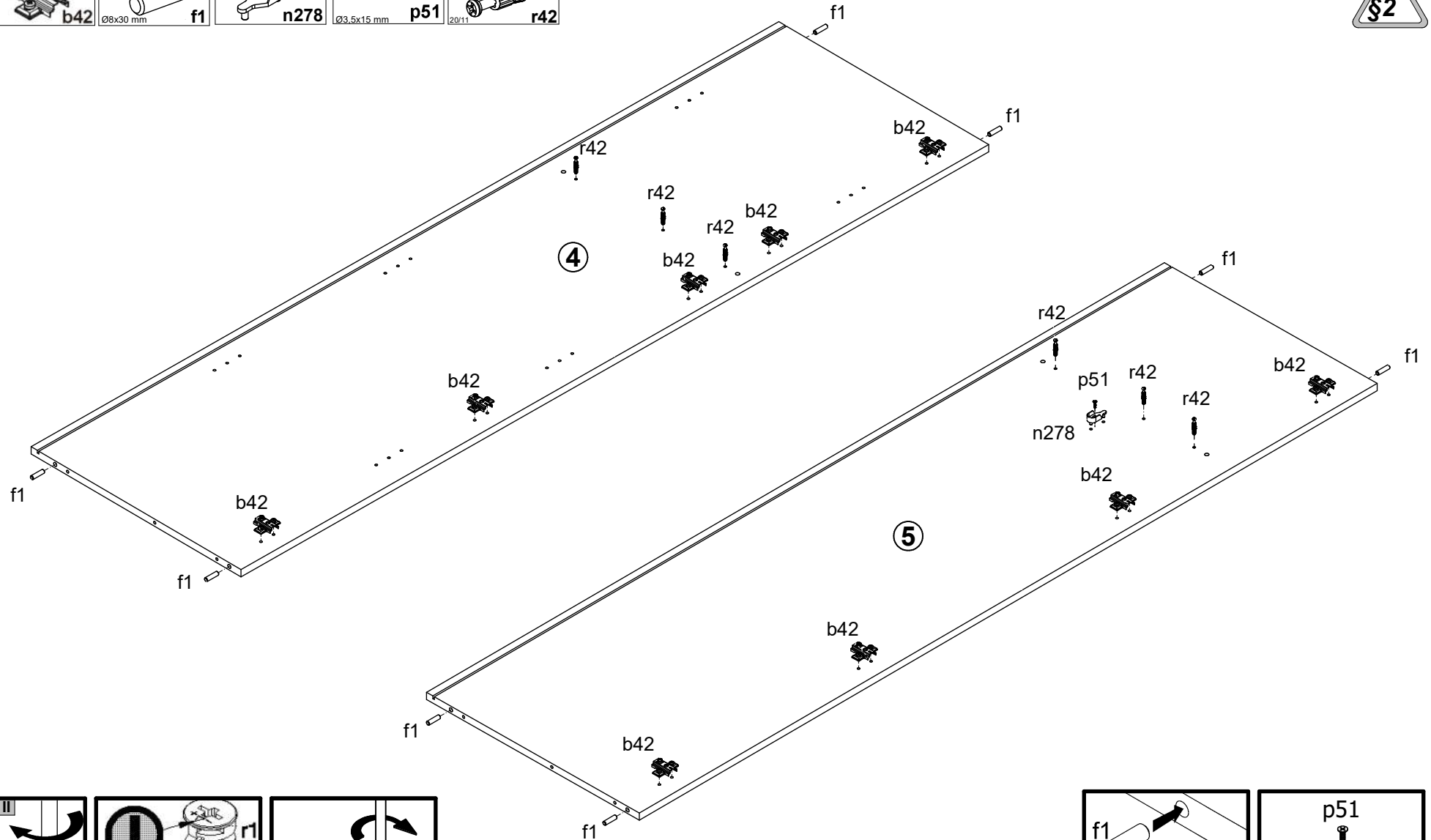

2

- 4x $\varnothing 8 \times 30$ mm f1
- 1x n278
- 1x $\varnothing 3.5 \times 15$ mm p51
- 6x r42
- 1x z28\1
- 1x $82 \times 9.5 \times 6.5$ mm z28\2
- 2x $\varnothing 3 \times 12$ mm z28\4

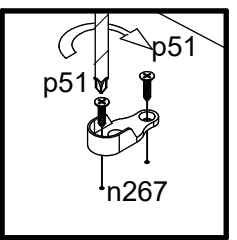
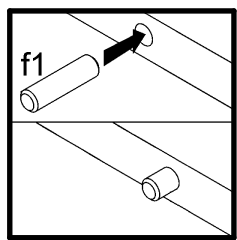
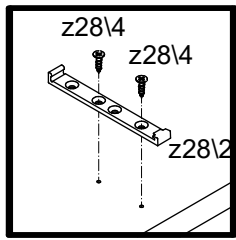
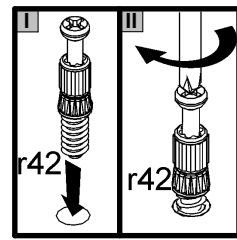
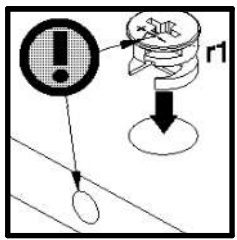
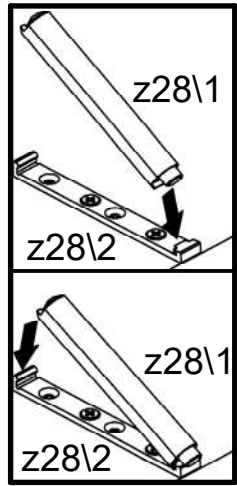
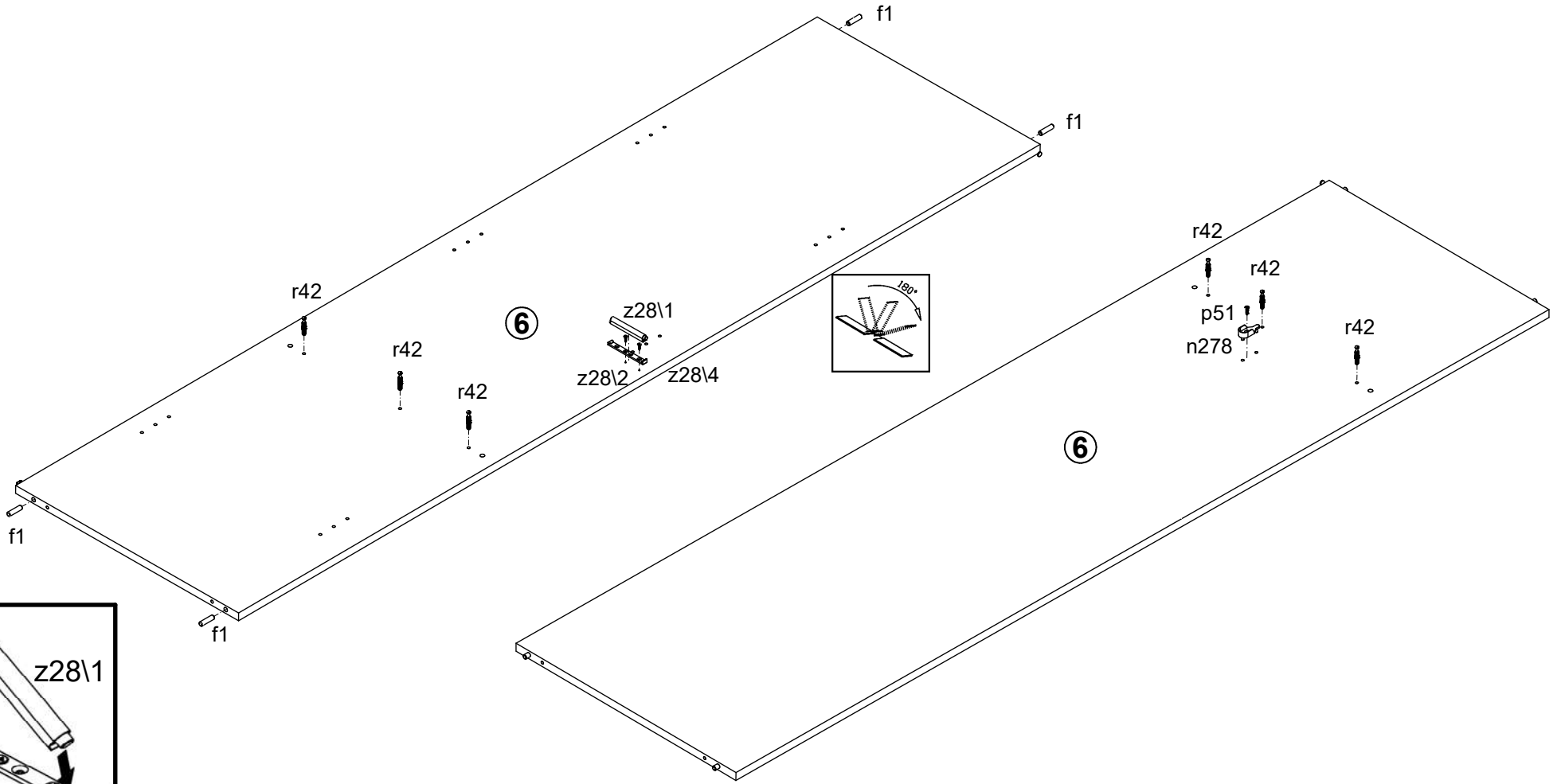

3

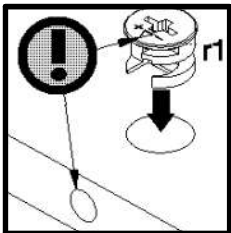
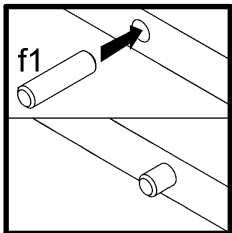
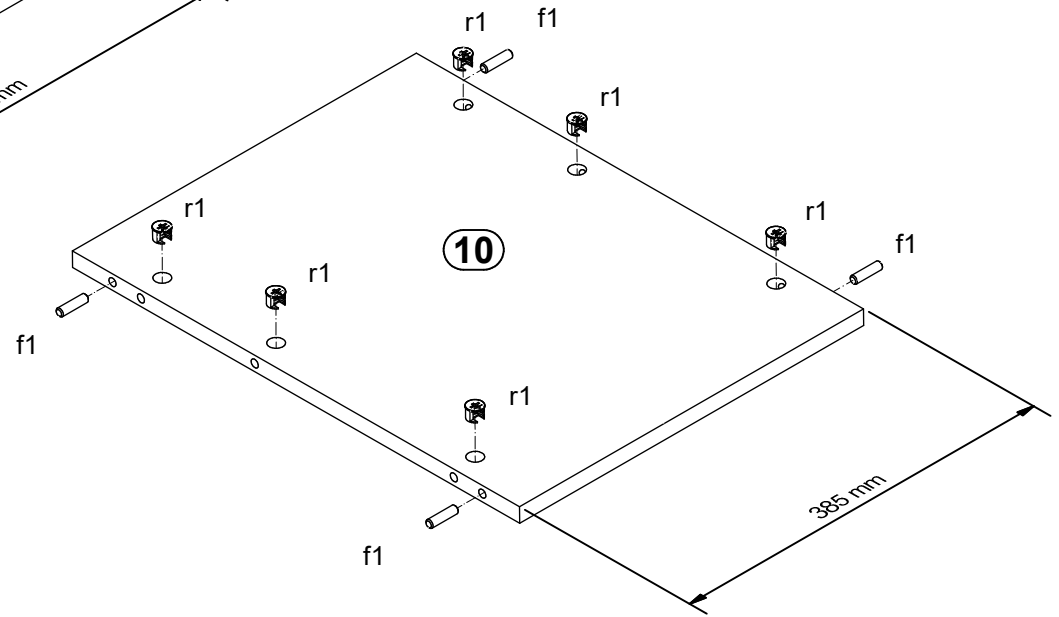
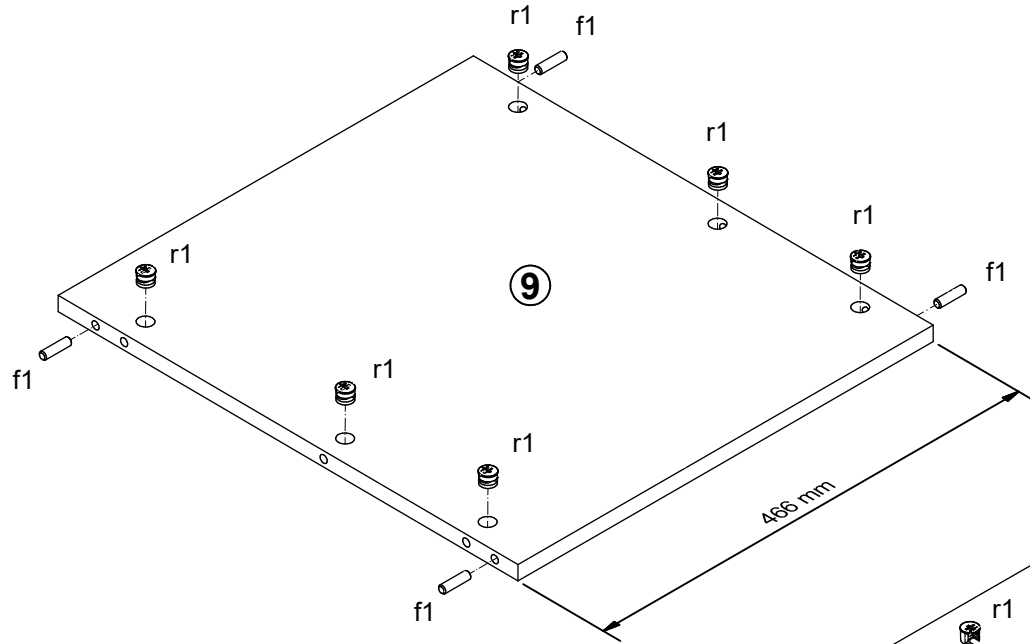
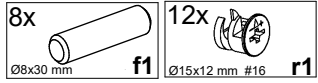

4

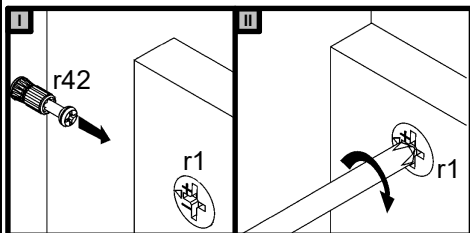
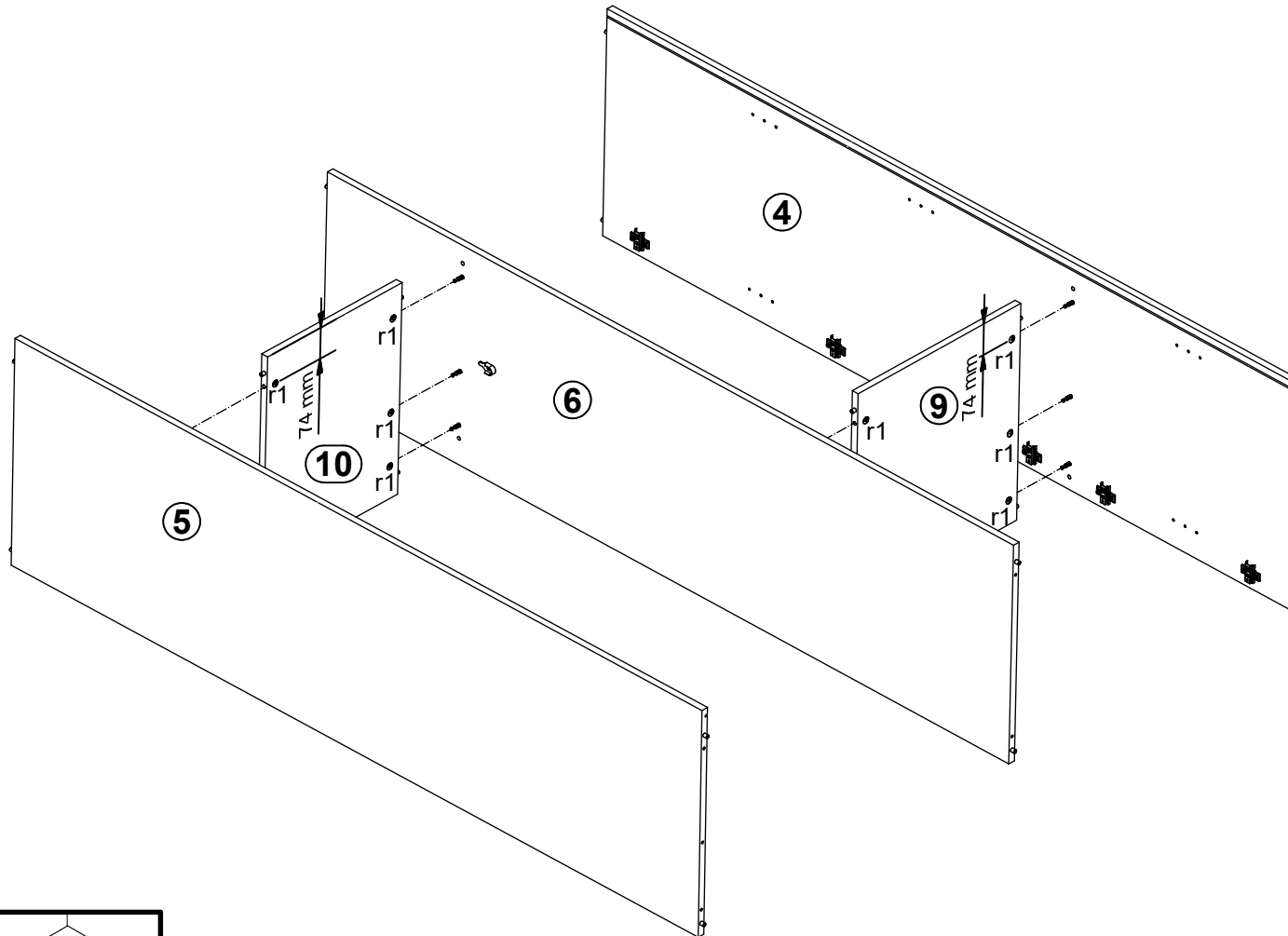

5

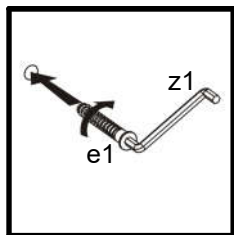
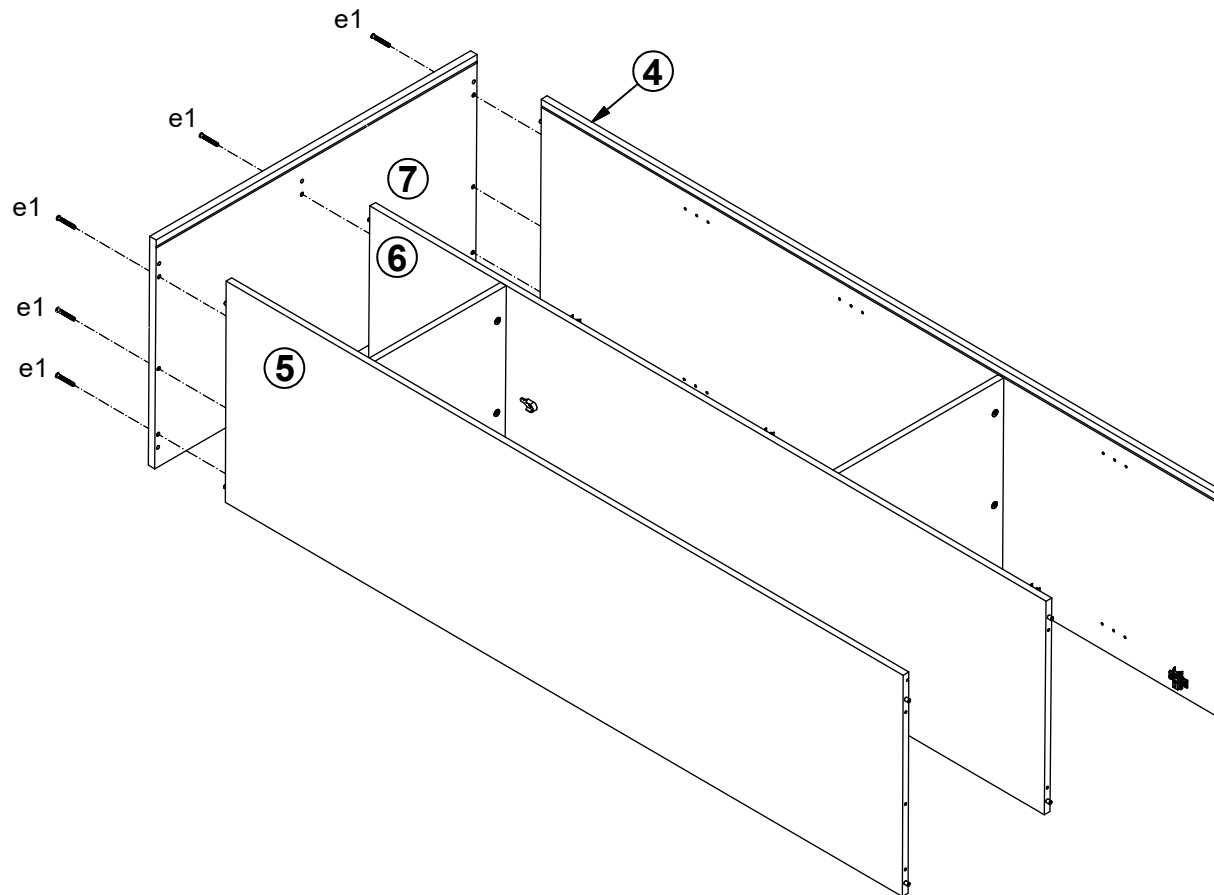
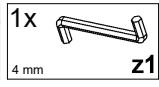

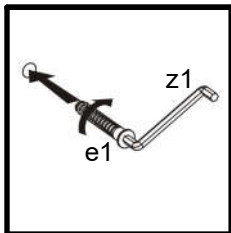
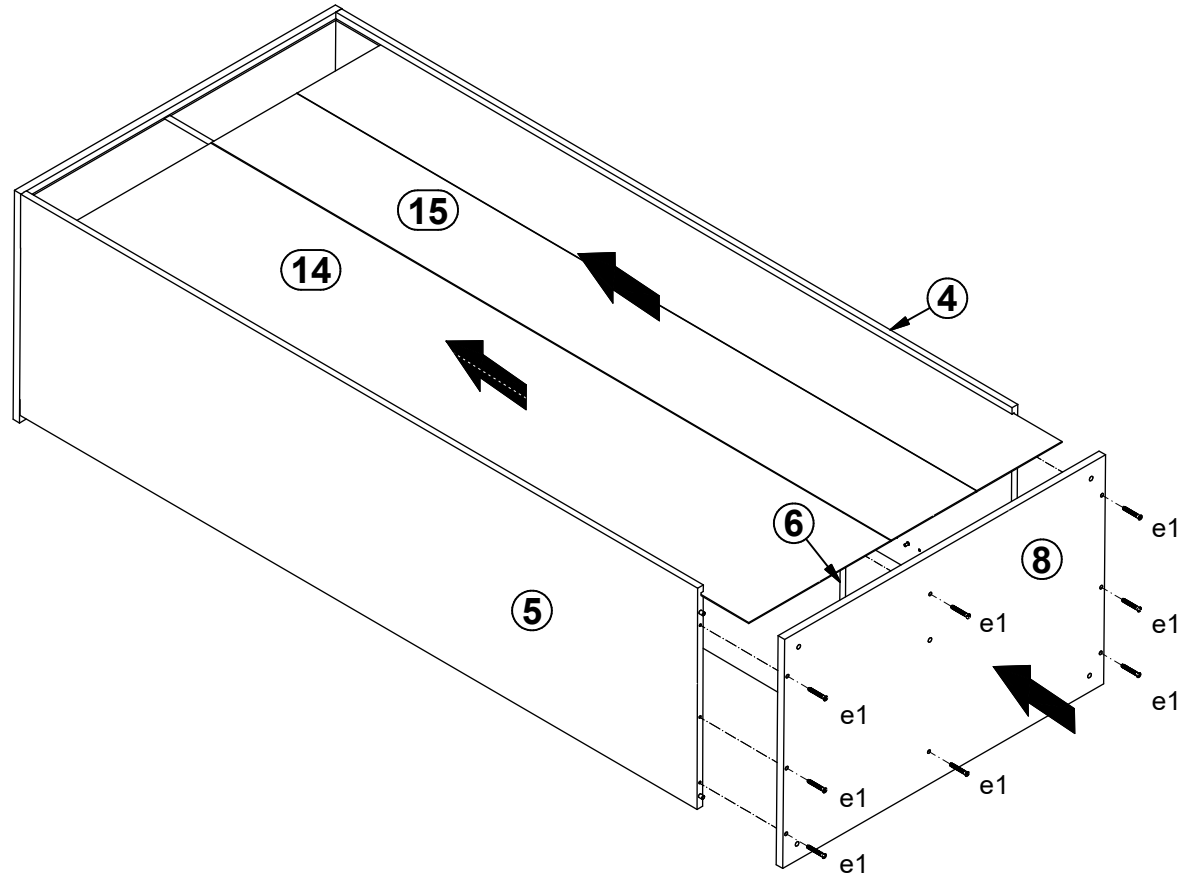
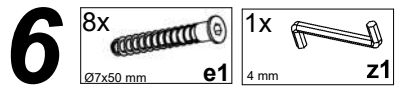

7

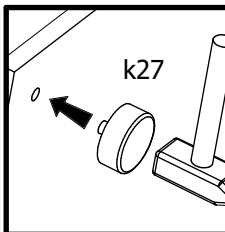
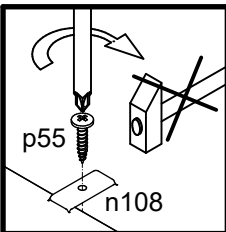
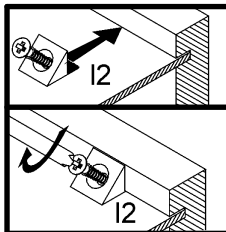
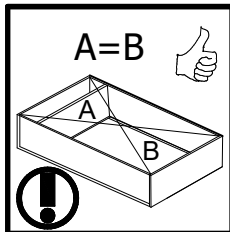
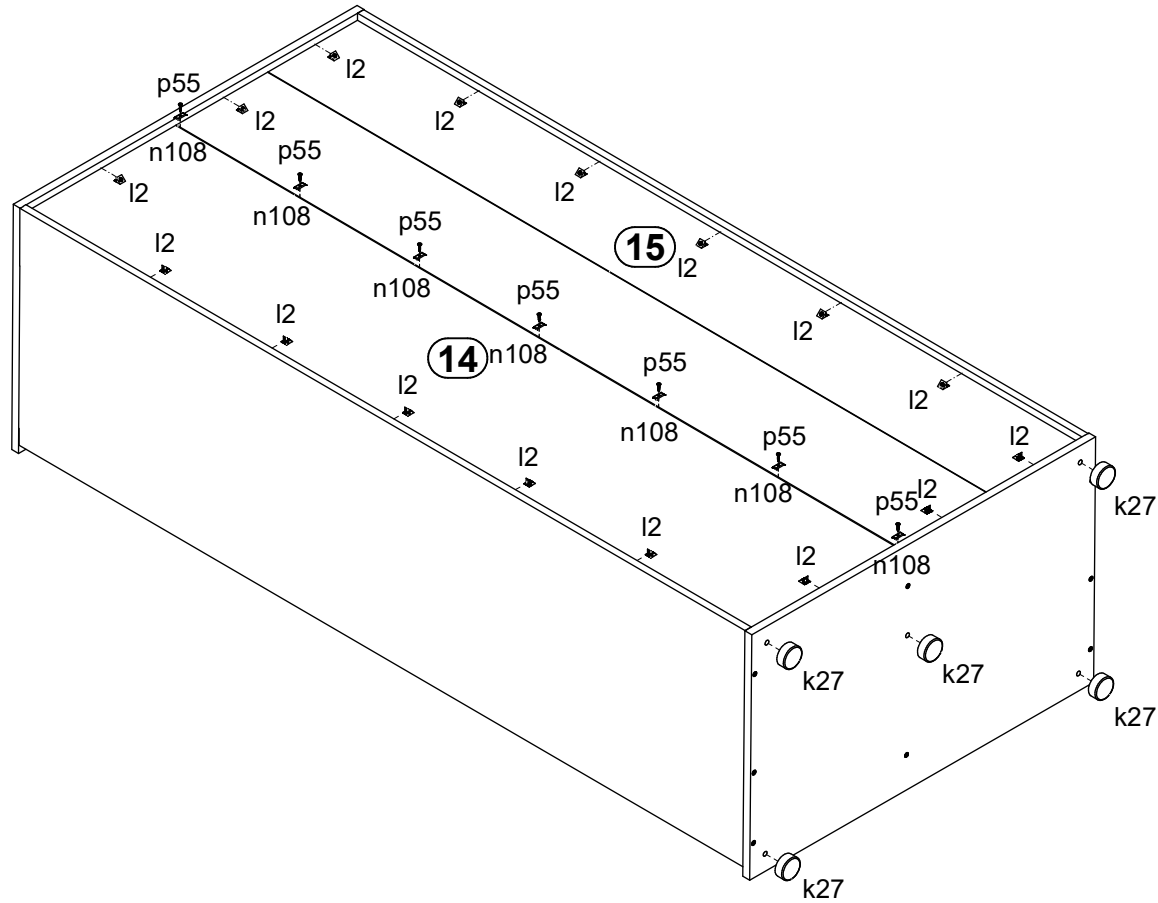
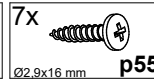
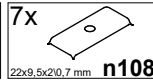
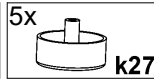
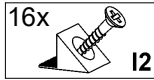



8

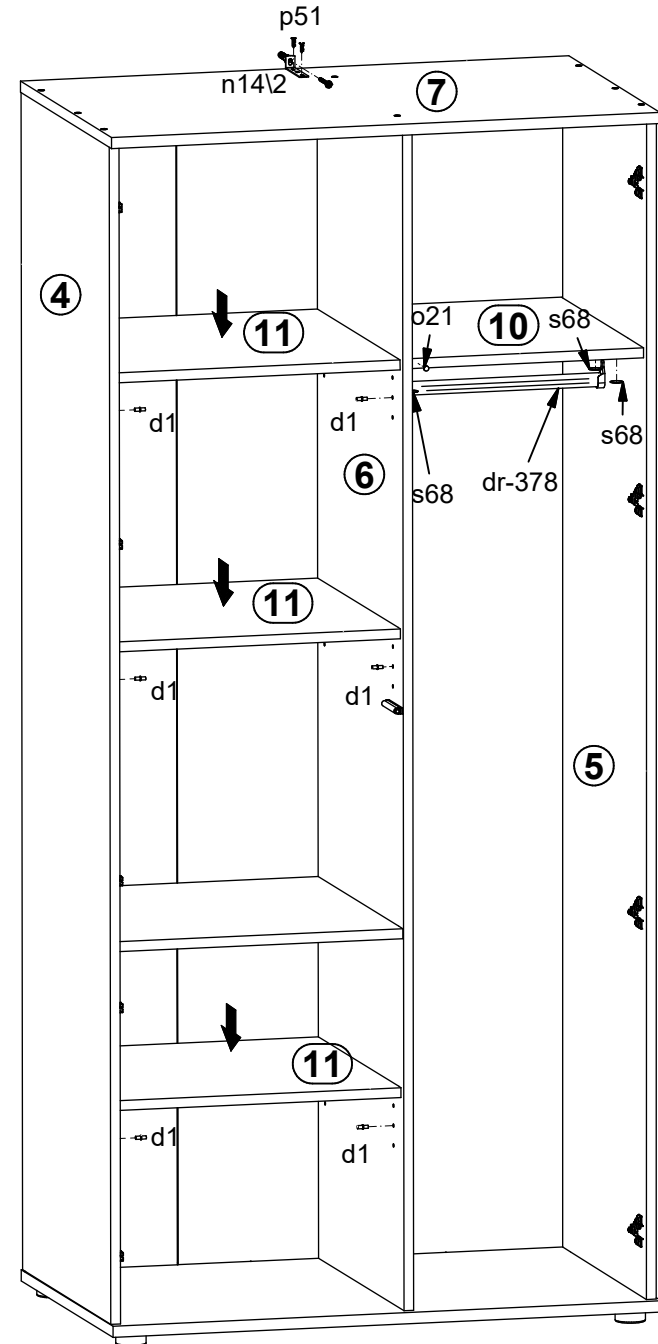
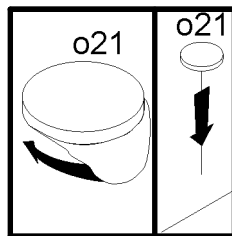
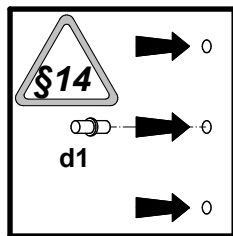
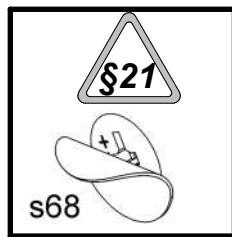
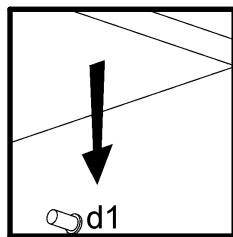
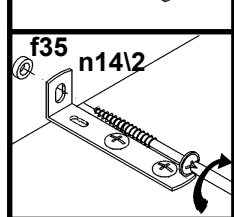
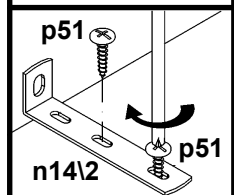
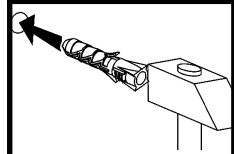
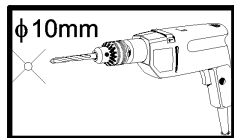

- 12x $\varnothing 5 \times 17$ mm d1
- 1x n14\2
- 1x silikon o21
- 2x $\varnothing 3,5 \times 15$ mm p51
- 6x $\varnothing 20$ mm s68



9

- 4x  a83
- 8x  p51
- 25x  f88

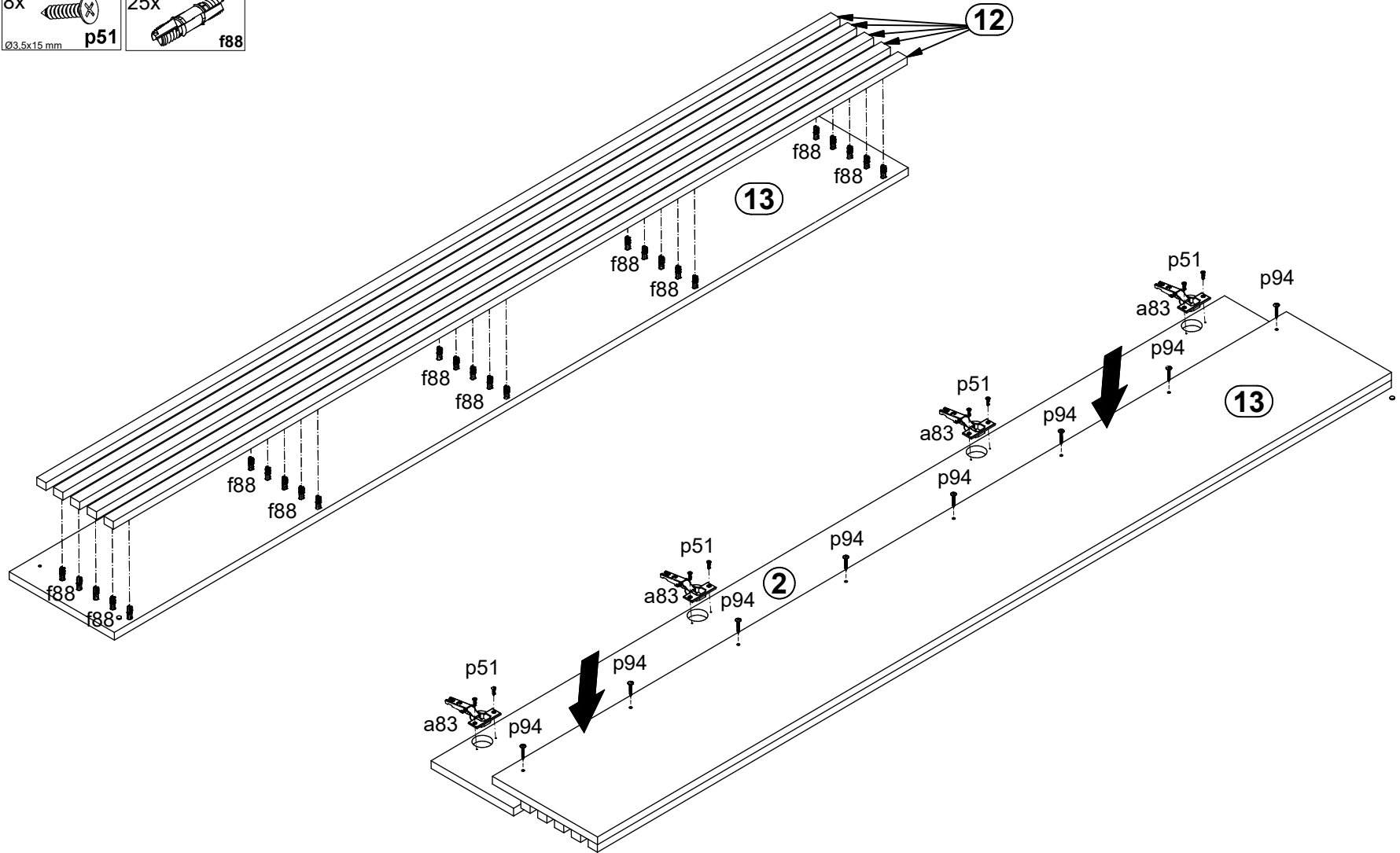

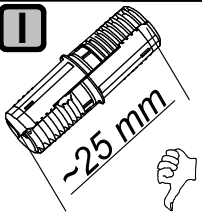
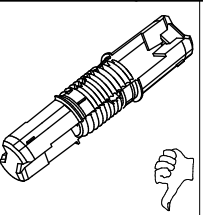
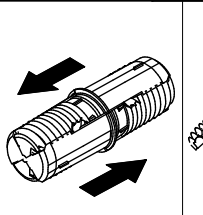
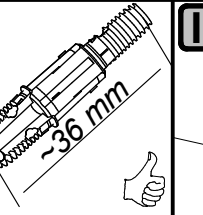
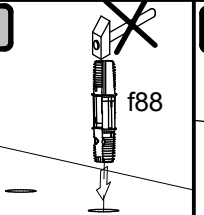
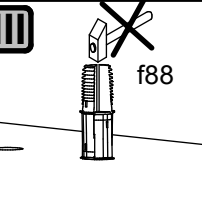
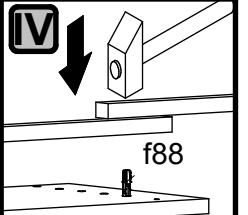
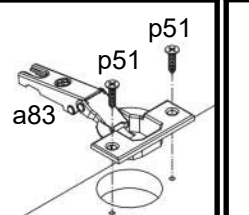
<p>I</p>  <p>~25 mm</p>		 <p>~36 mm</p>	<p>II</p>  <p>f88</p>	<p>III</p>  <p>f88</p>	<p>IV</p>  <p>f88</p>	 <p>a83 p51</p>	 <p>p94</p>
---	---	---	---	---	---	--	--

10

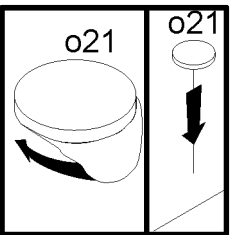
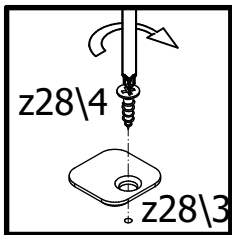
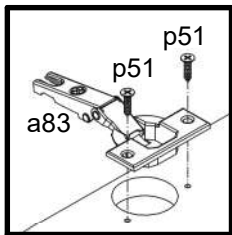
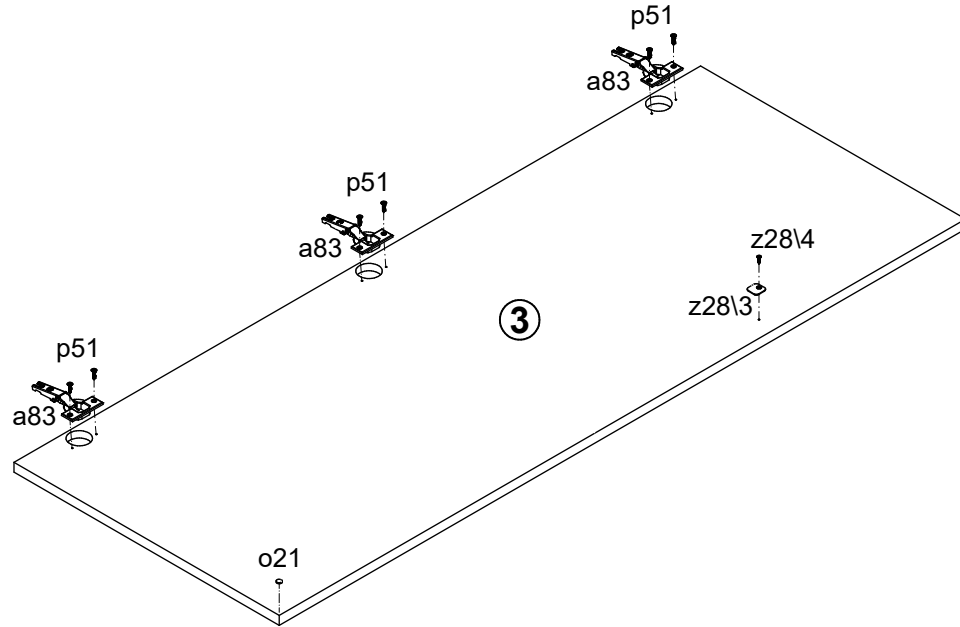
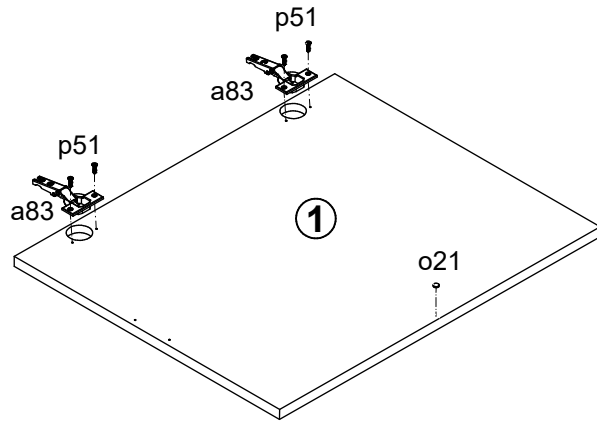
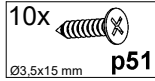
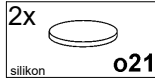
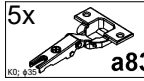

11

