

A S620-SZF1D2M3S VABRES

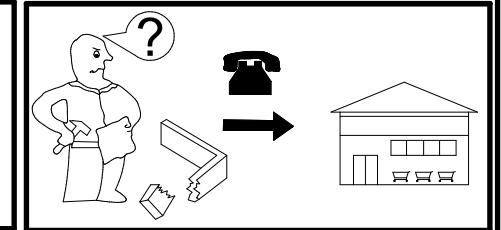

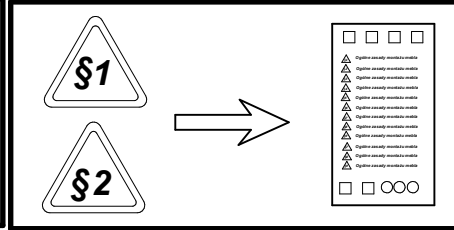

A	B1	B2	C1	C2	C3	D
1	S620-0030	-2	994	198	16	1/5
2	S620-0031	-2	1888	296	16	1/5
3	S620-0032	-2	1284	495	15	2/5
4	S620-0033	-2	1284	495	15	2/5
5	S620-1032	-2	1896	540	16	3/5
6	S620-1033	-2	1896	540	16	3/5
7	S620-1034	-3	1896	540	16	4/5
8	S620-2020	-3	1501	558	18	5/5
9	S620-2021	-3	1501	558	18	5/5
10	S620-3023	-2	965	516	22	4/5
11	S620-3024	-2	486	504	16	4/5
12	S620-3025	-2	485	494	16	4/5
13	S620-5060	-6	1888	22	16	1/5
14	S620-7005	-6	1888	250	16	1/5
15	S620-9009	-3	938	457	2,5	5/5
16	S620-9310	-2	1906	973	2,5	3/5
17	S620-9311	-2	1906	495	2,5	3/5
18	WSR3-5009	-	450	140	12	5/5
19	WSR3-5010	-	450	140	12	5/5
20	ZS7-5137	-	916	140	15	5/5
21	dr-958		958	30	15	4/5

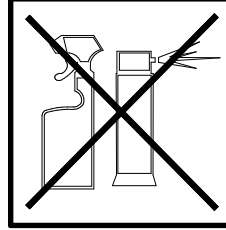
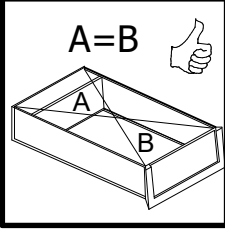
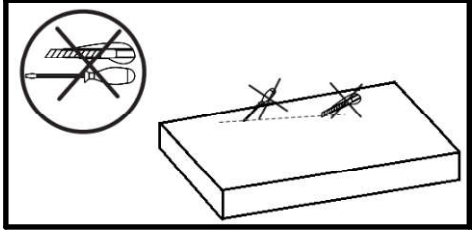
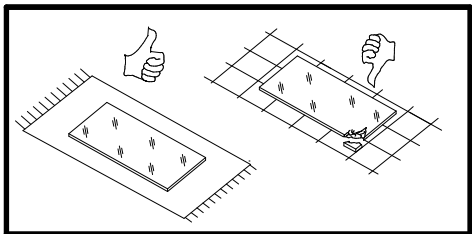
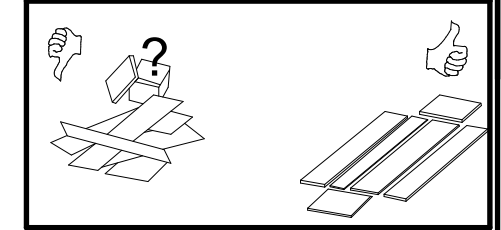
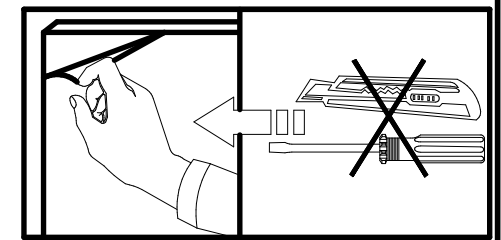
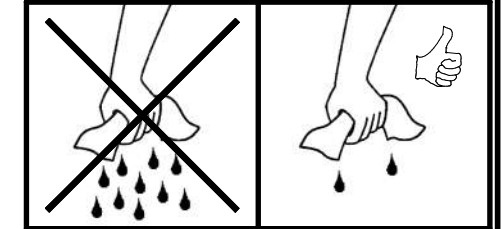
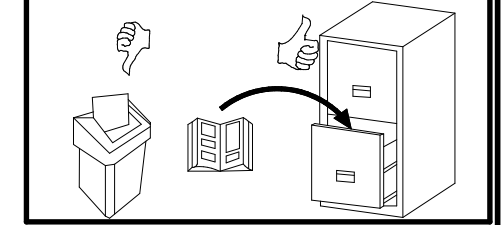
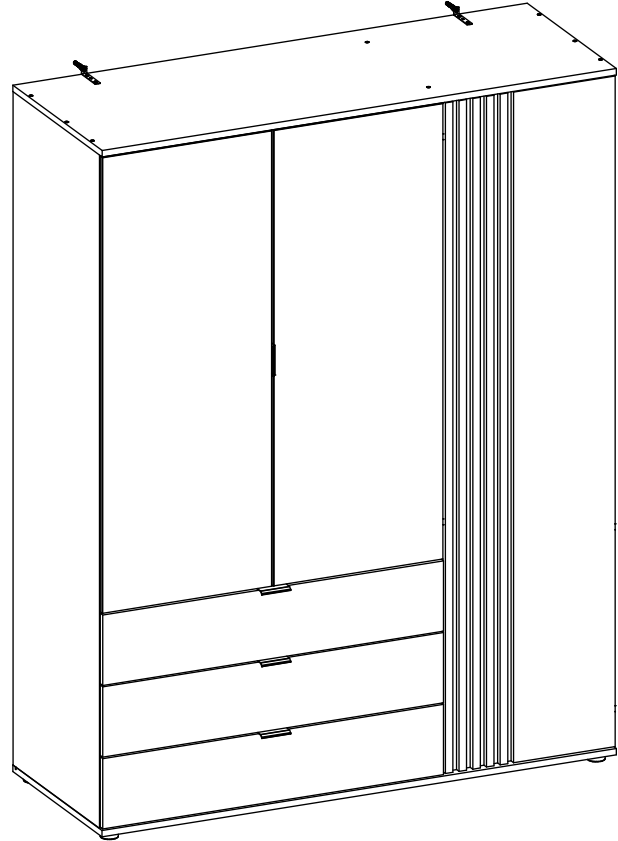
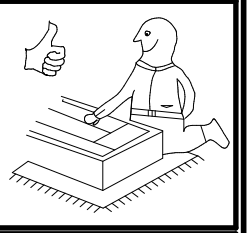
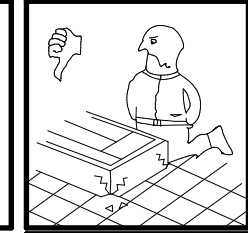
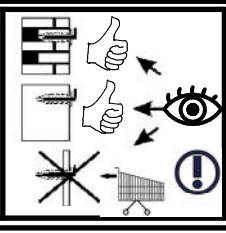
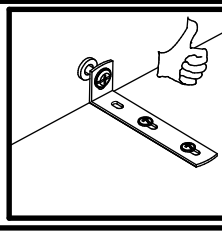
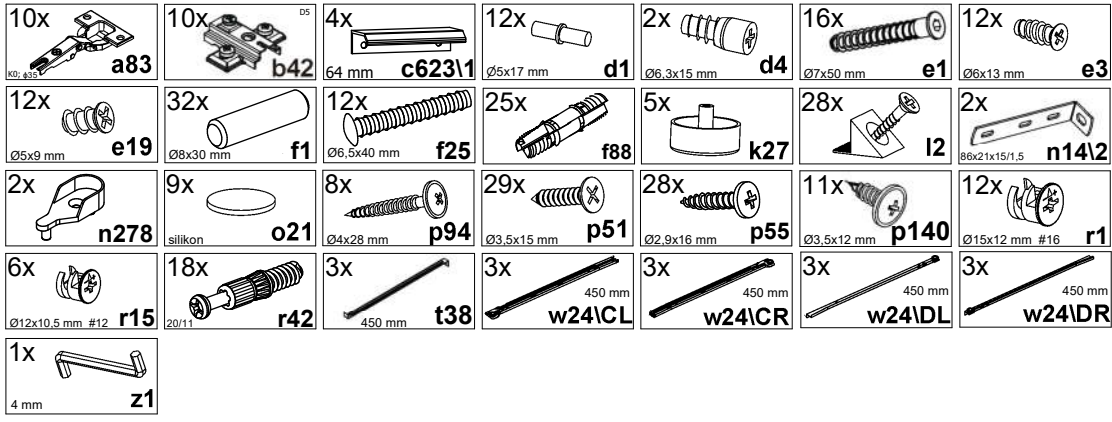
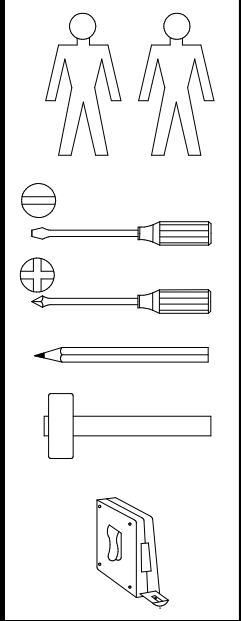
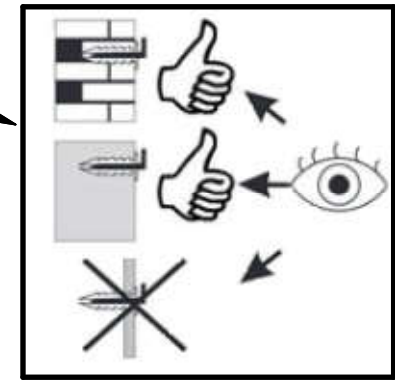

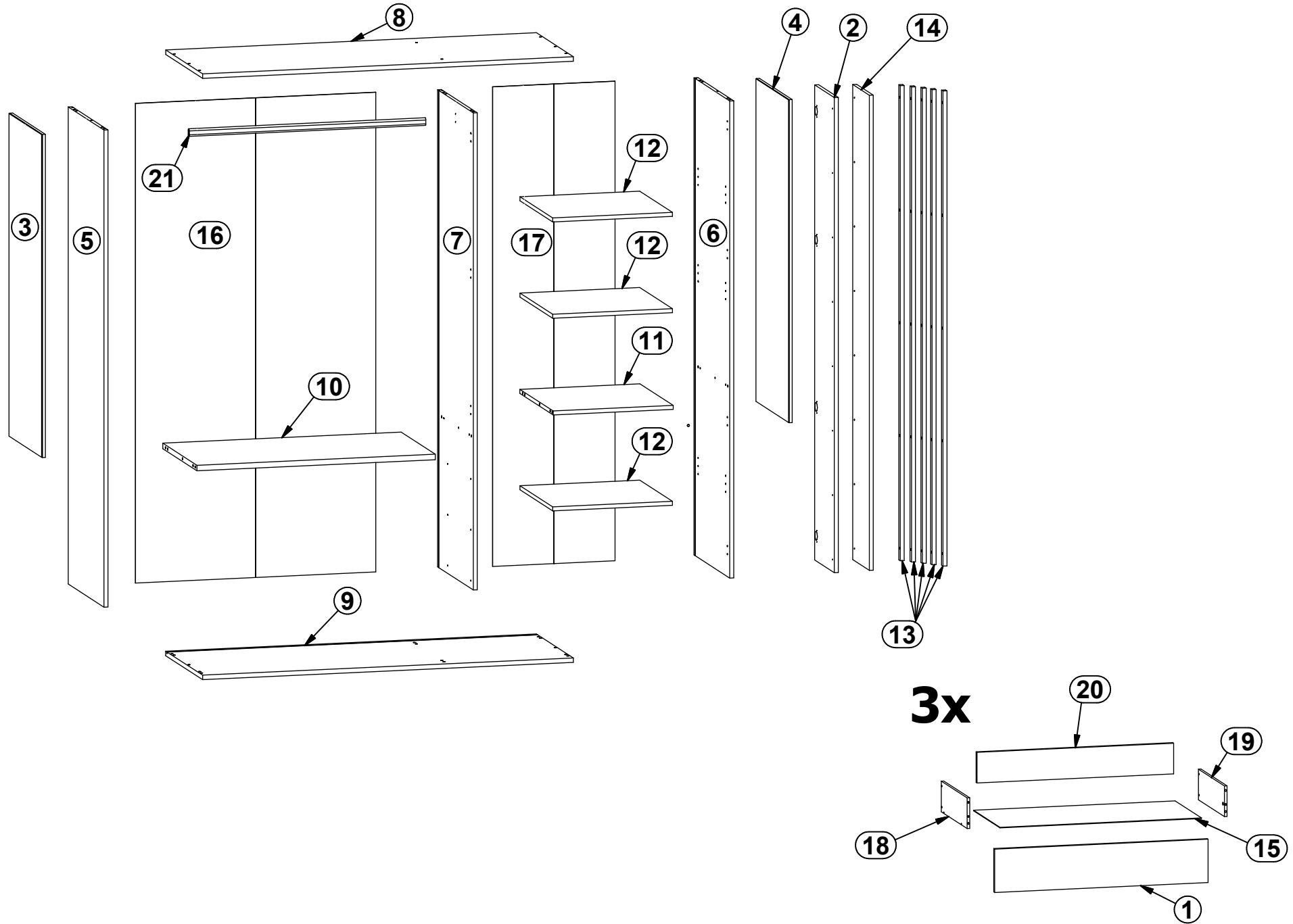

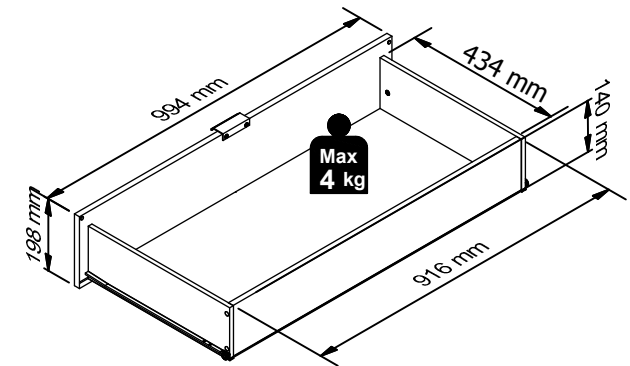
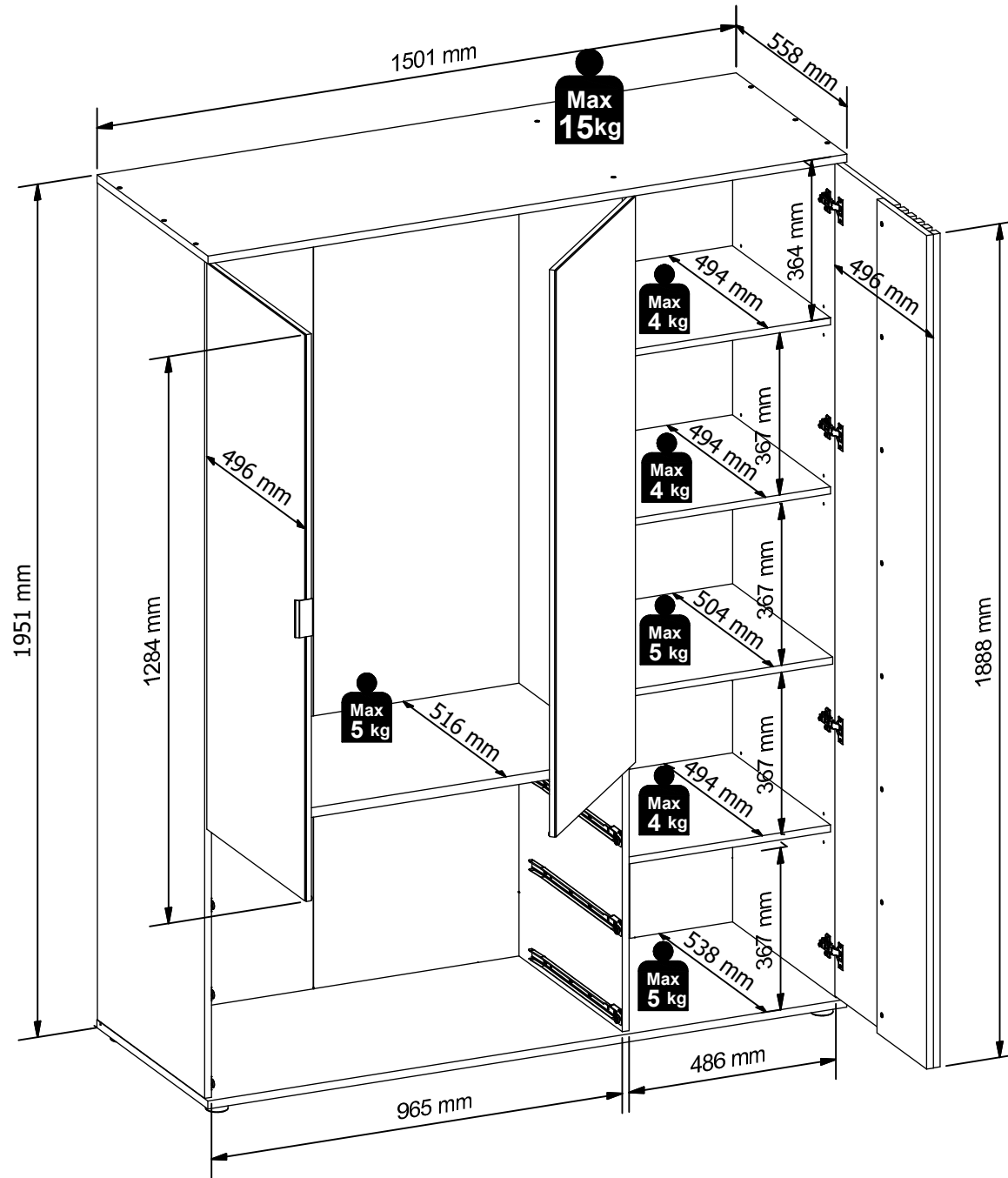

1

- 7x  b42
- 6x  e3 $\varnothing 6 \times 13$ mm
- 8x  f1 $\varnothing 8 \times 30$ mm
- 1x  n278
- 1x  p51 $\varnothing 3,5 \times 15$ mm
- 6x  r42 $\varnothing 20/1$
- 3x  w24\CL 450 mm

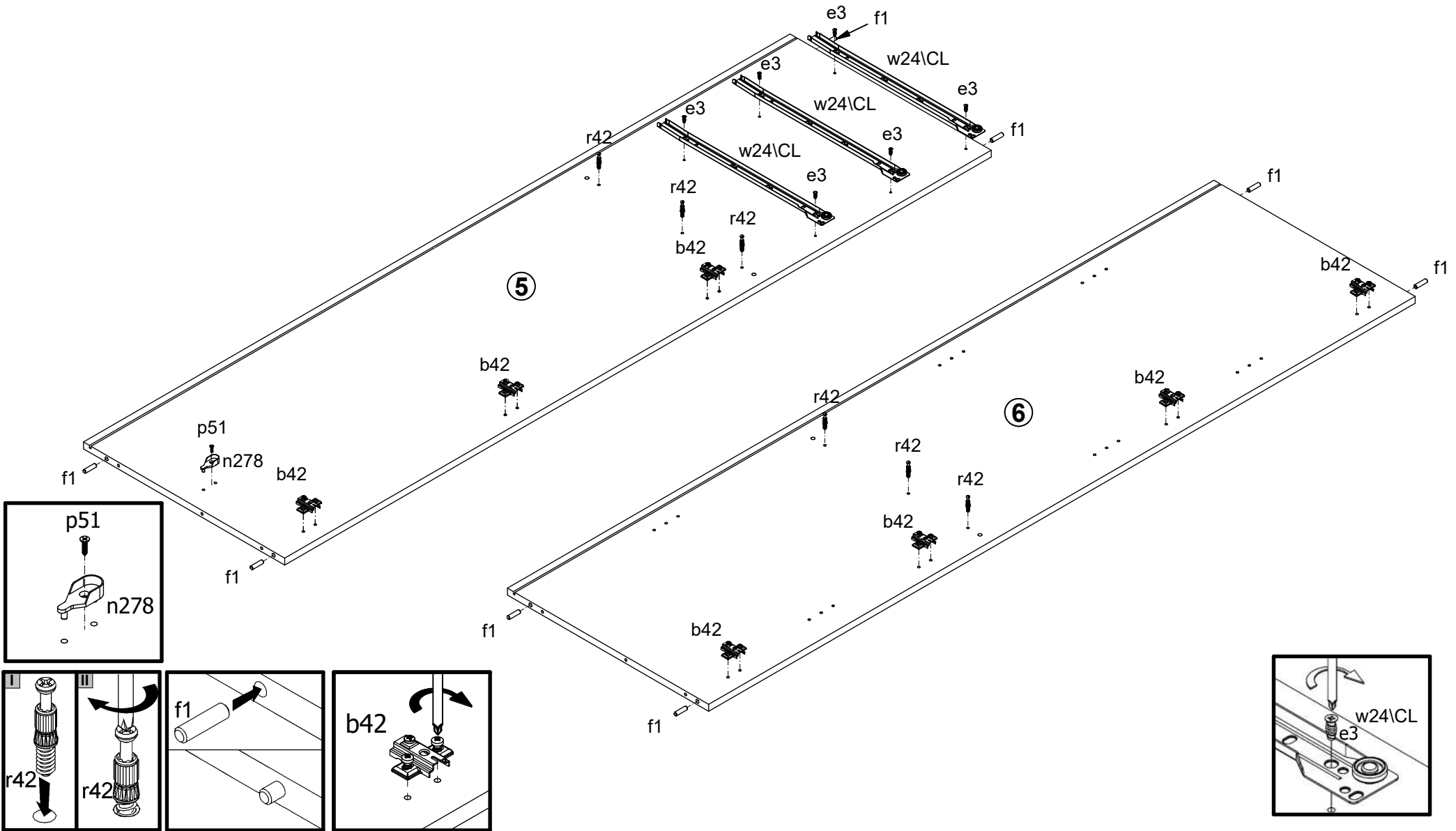

2

- 3x  b42
- 6x  e3 $\varnothing 6 \times 13 \text{ mm}$
- 4x  f1 $\varnothing 6 \times 30 \text{ mm}$
- 1x  n278
- 6x  r42 $\varnothing 3,5 \times 15 \text{ mm}$
- 1x  p51 $\varnothing 3,5 \times 15 \text{ mm}$
- 3x  w24\CR 450 mm

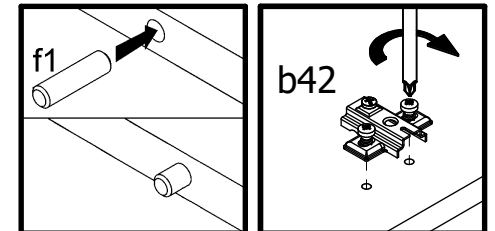
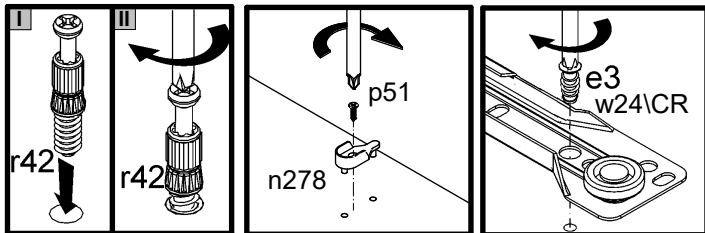
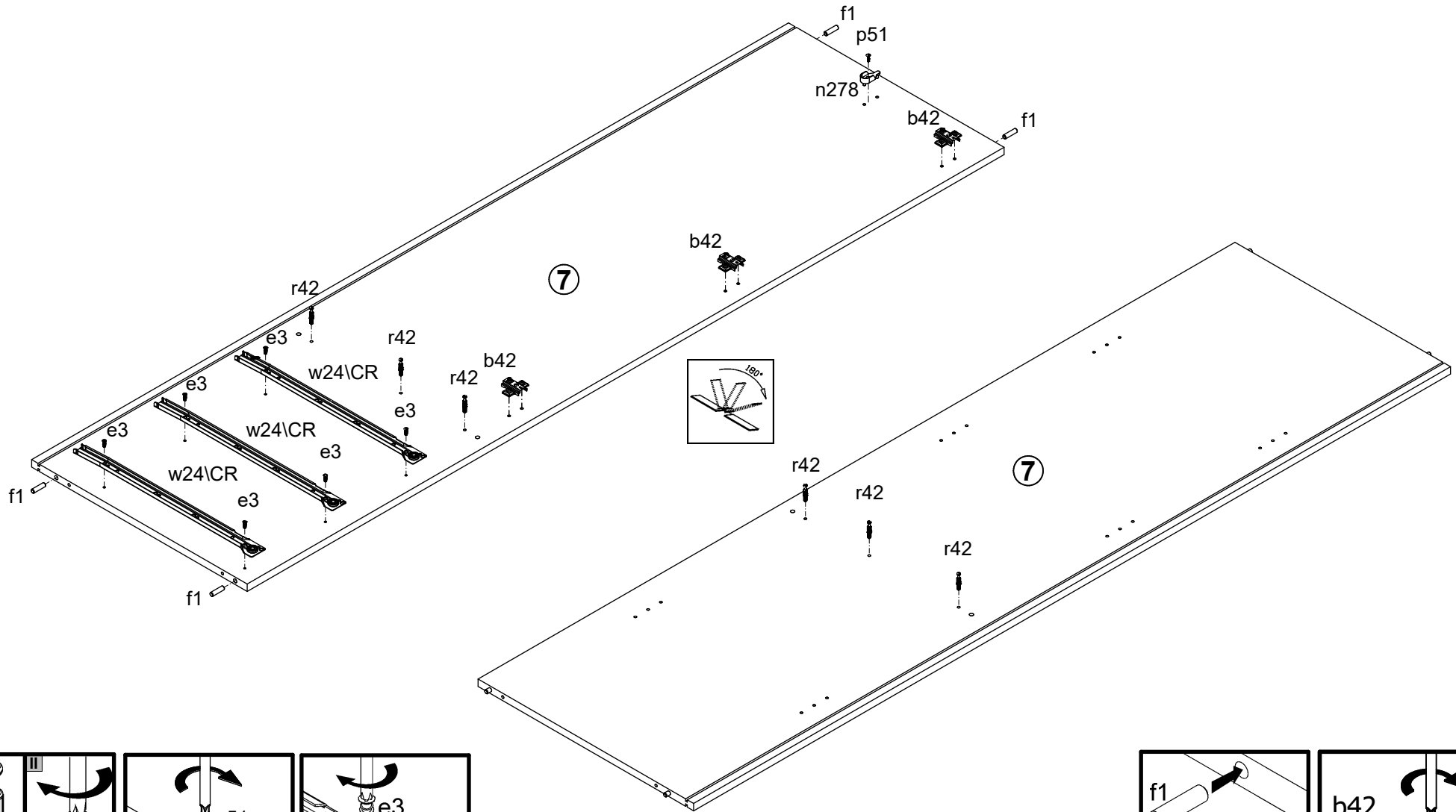

3

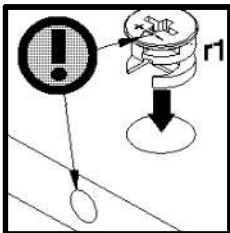
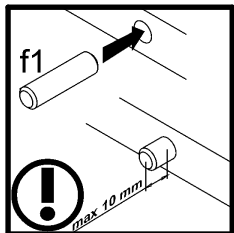
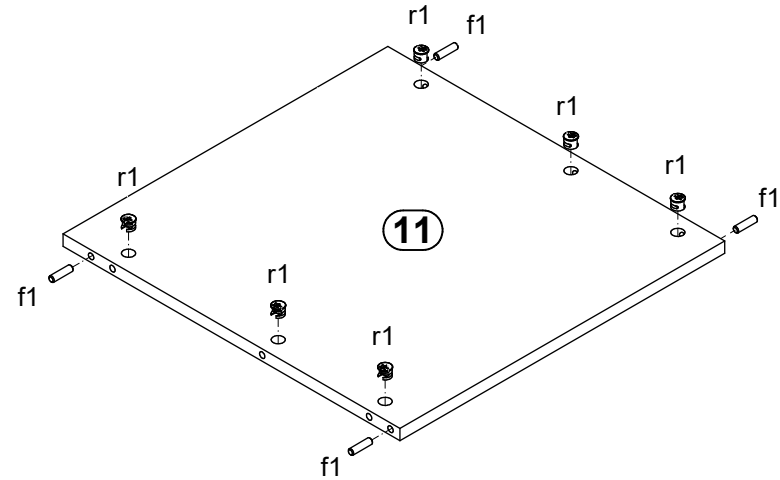
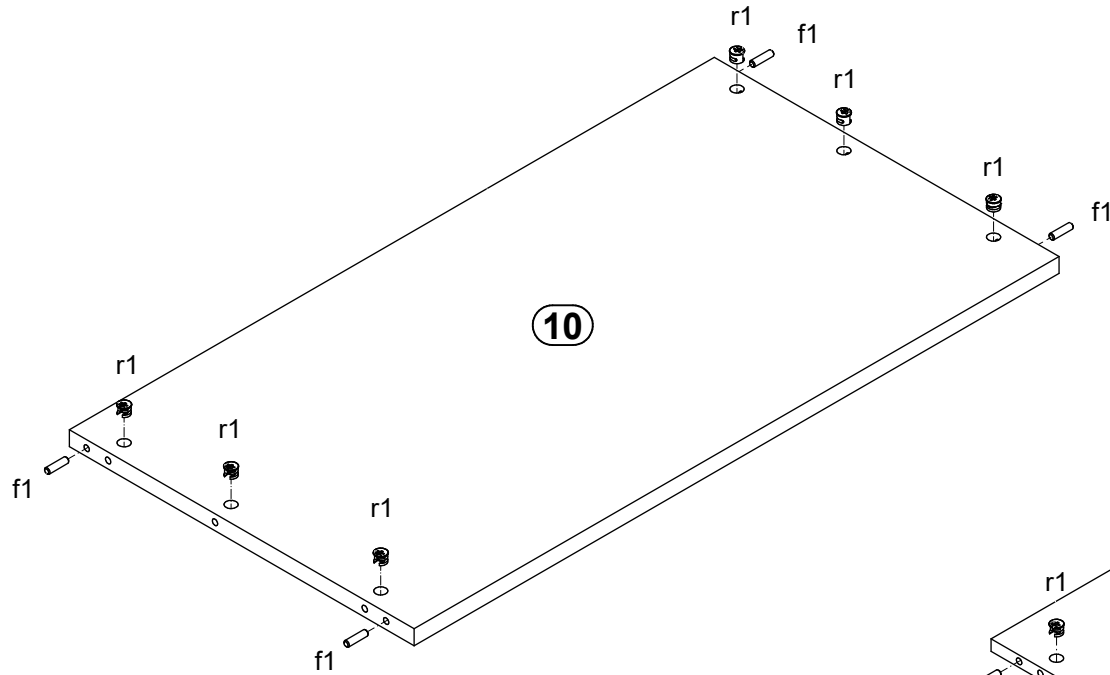
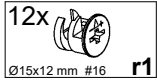
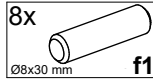

4

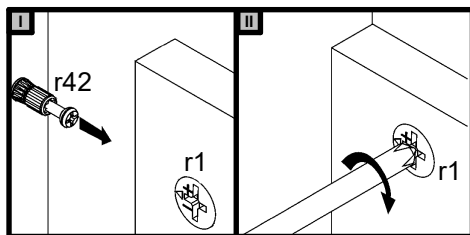
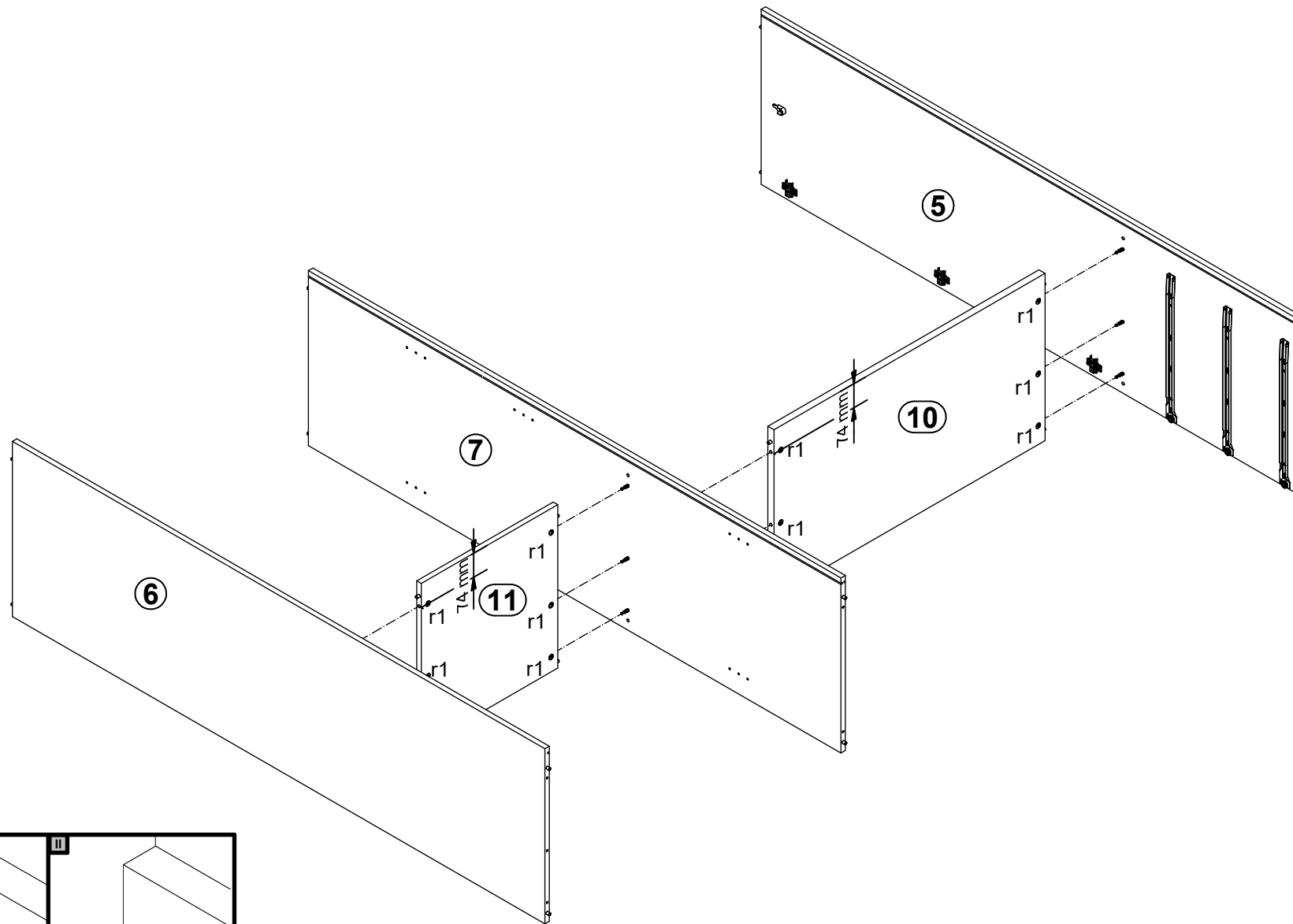

5

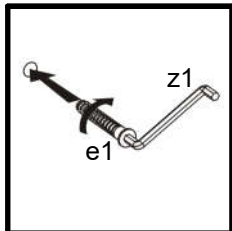
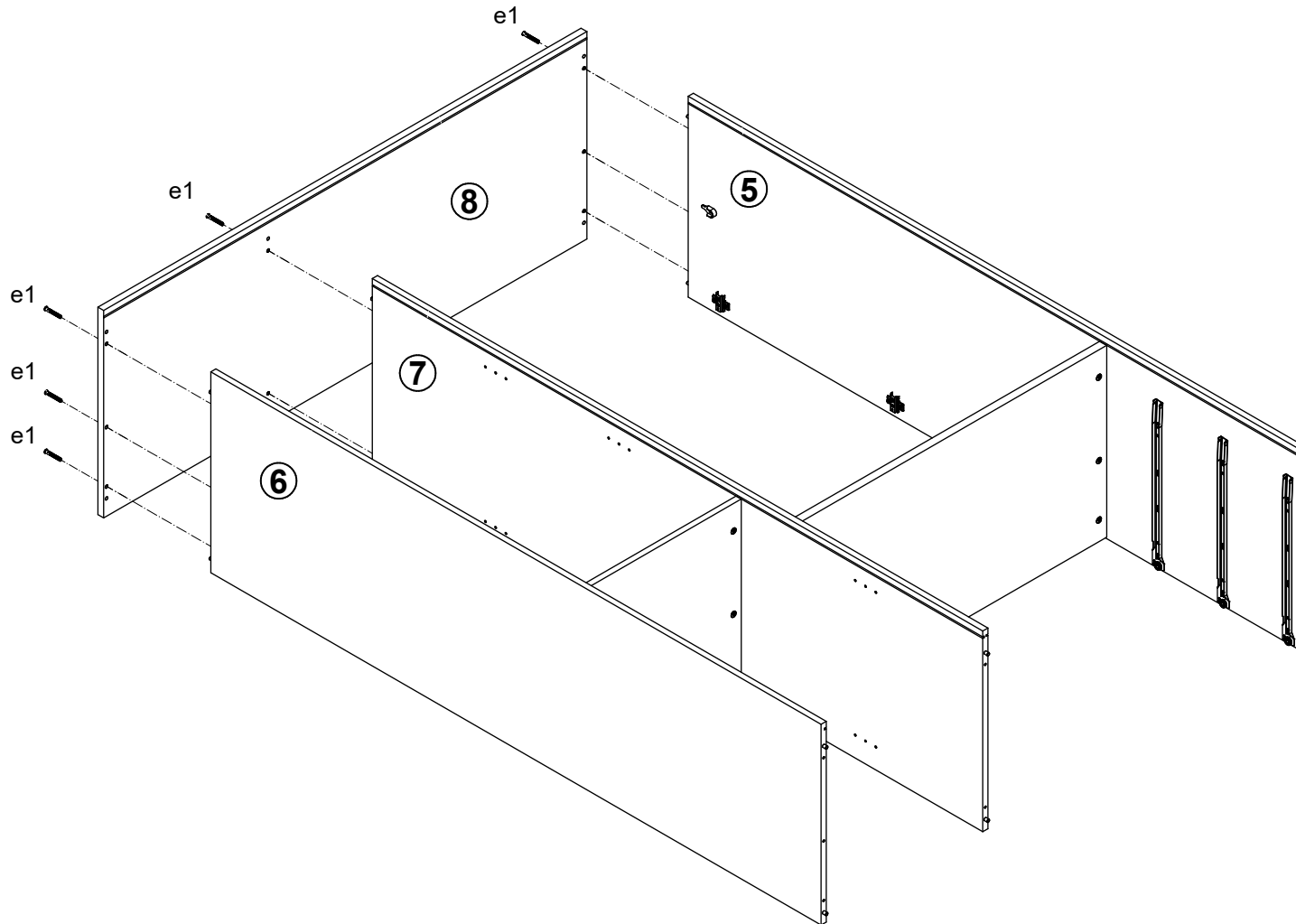
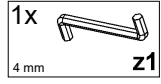

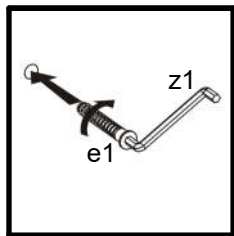
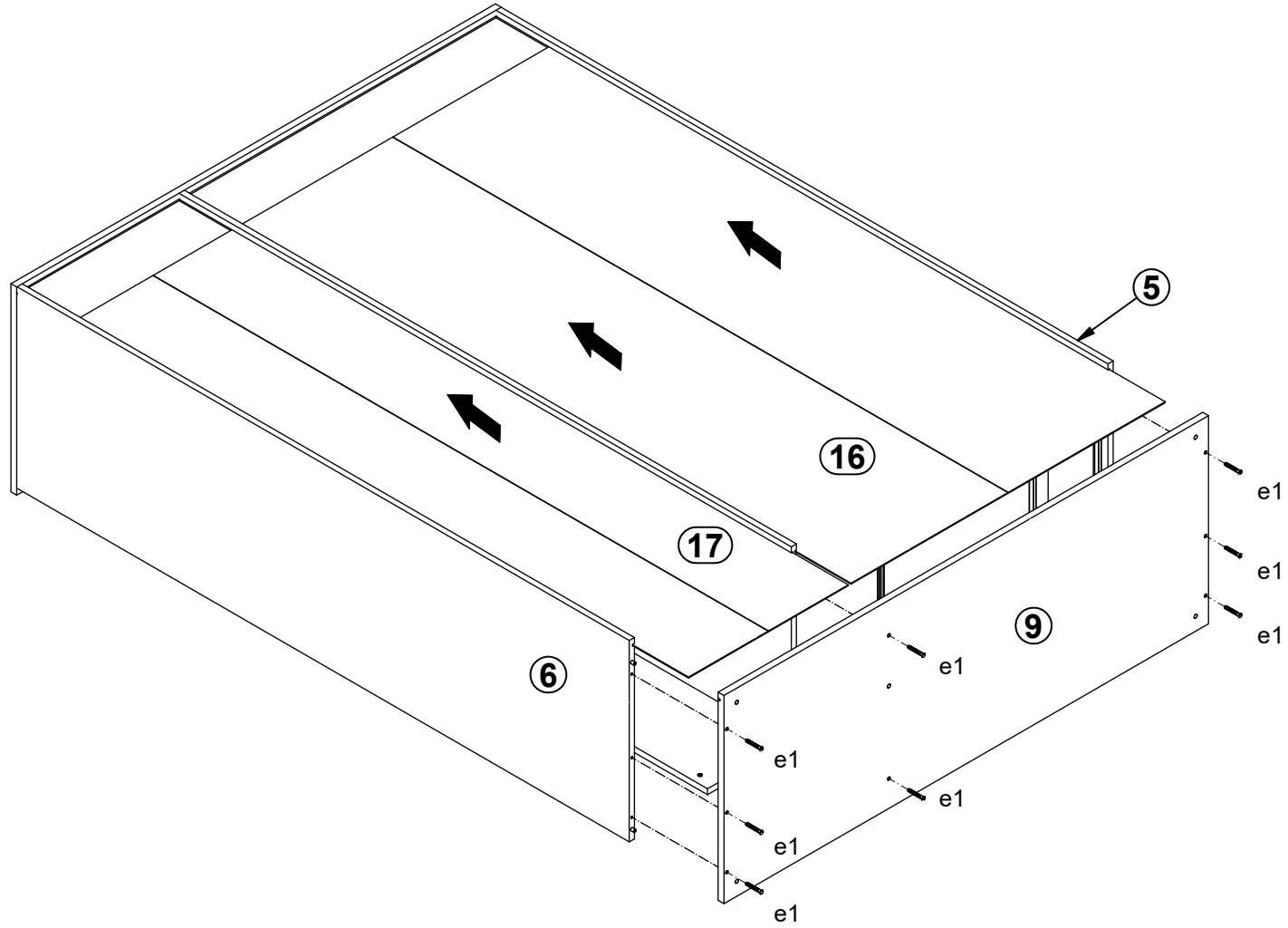
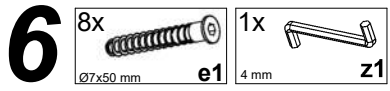

7

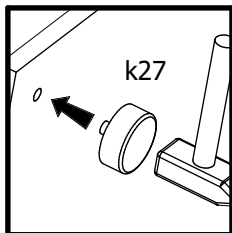
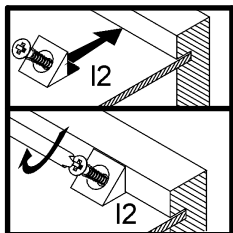
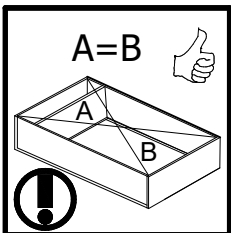
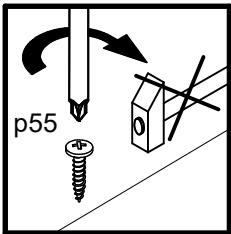
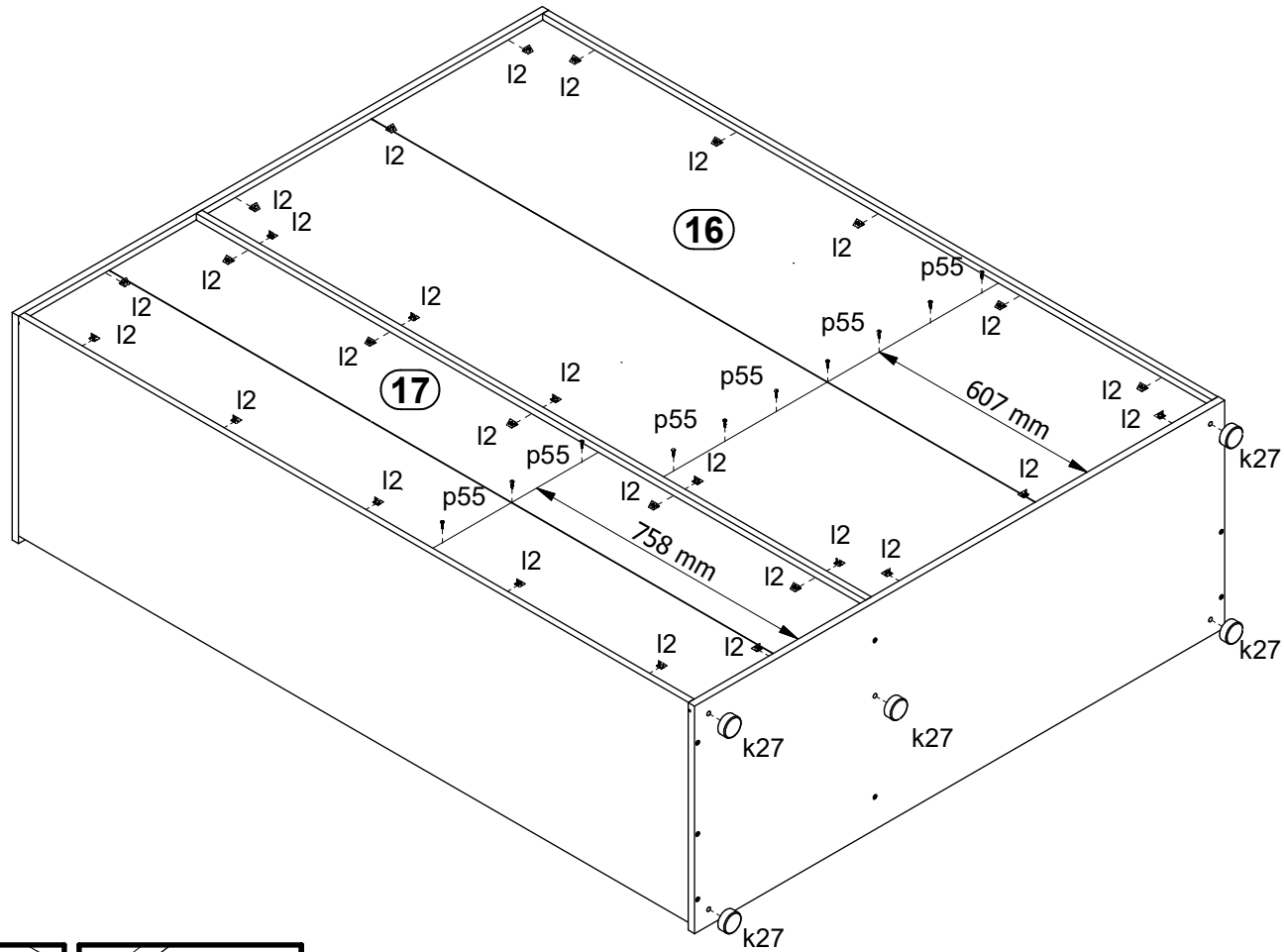
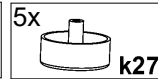
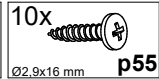

8

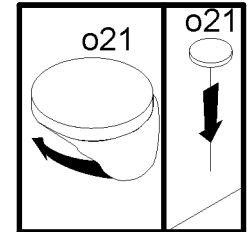
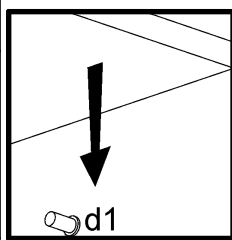
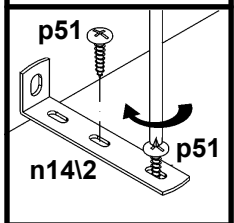
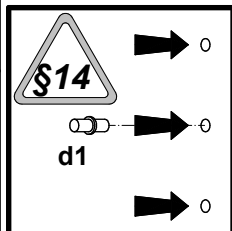
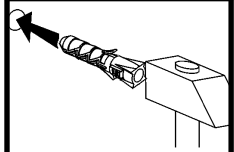
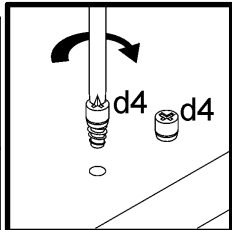
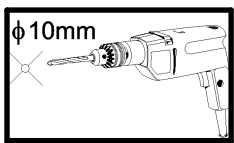
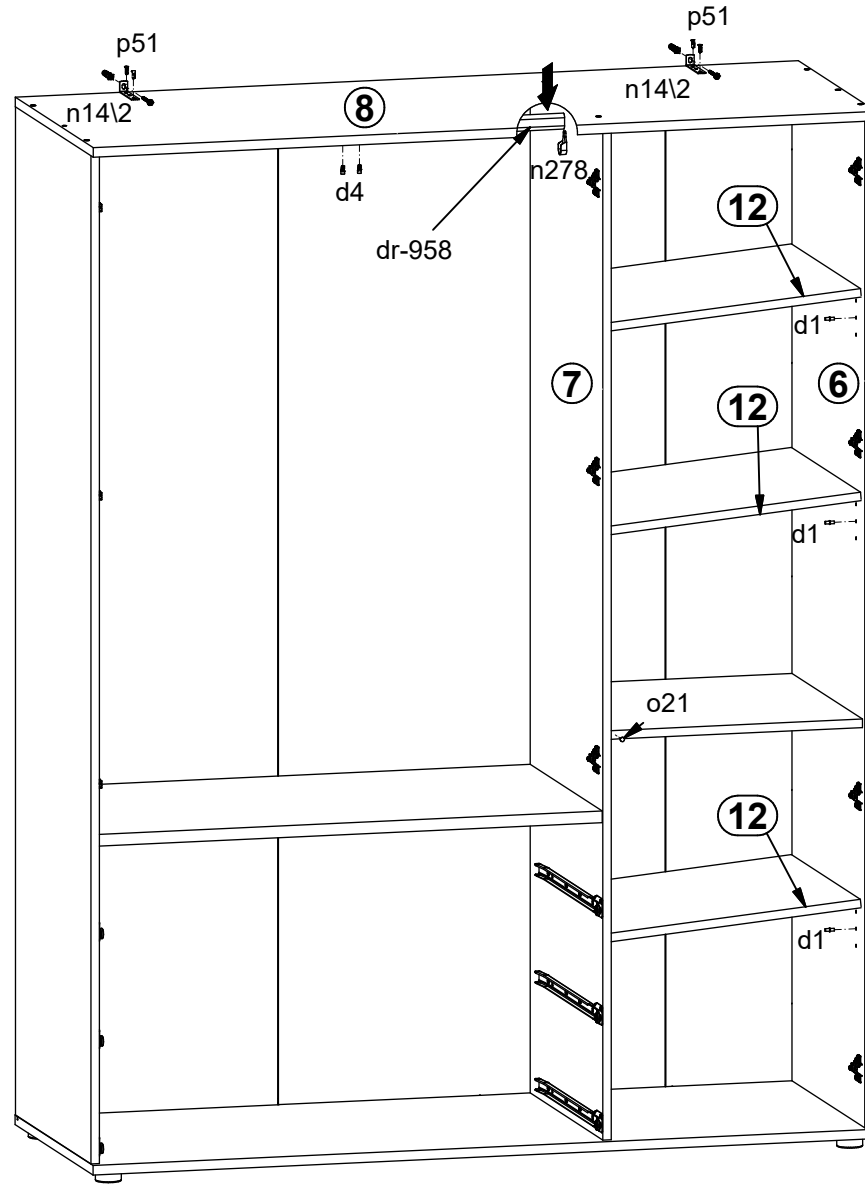
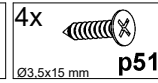
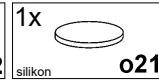
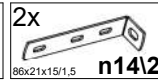
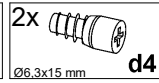
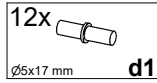



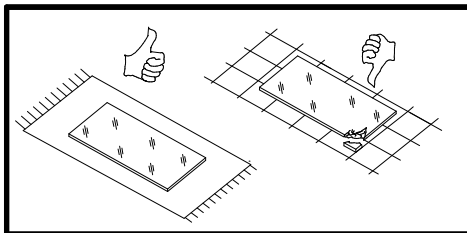
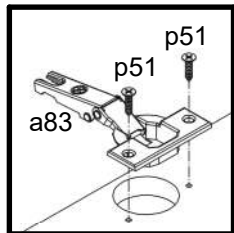
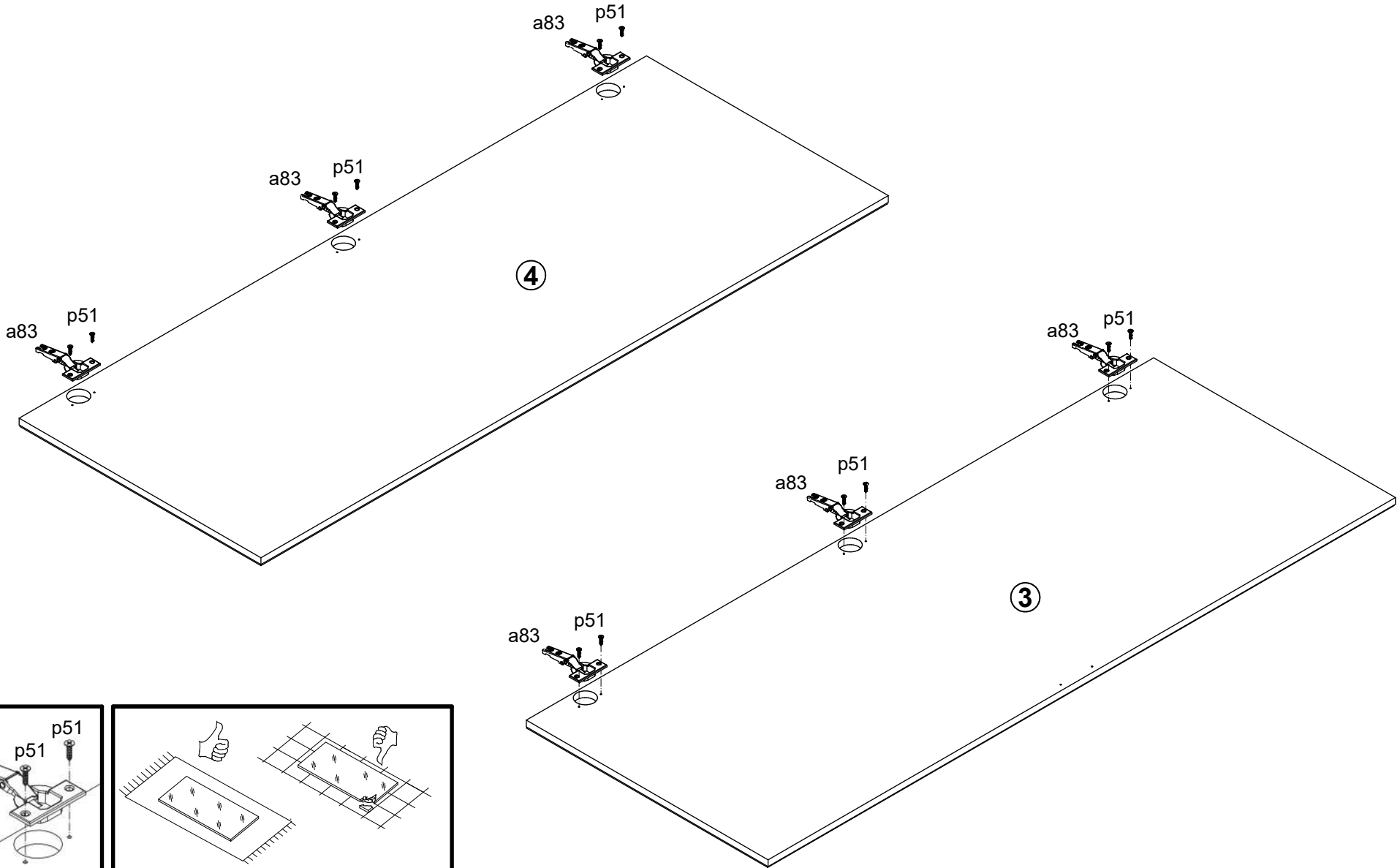
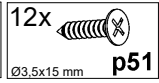
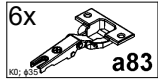



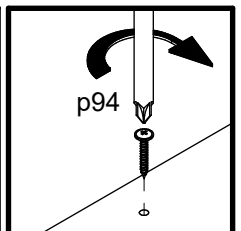
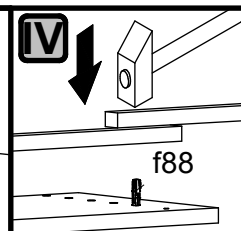
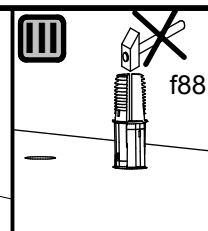
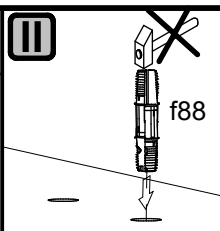
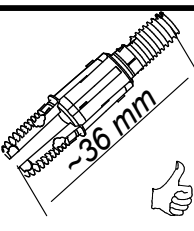
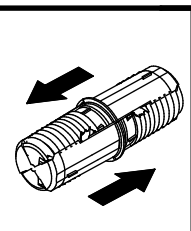
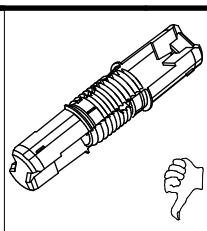
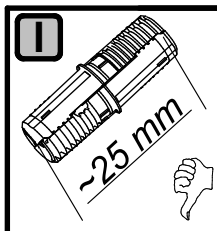
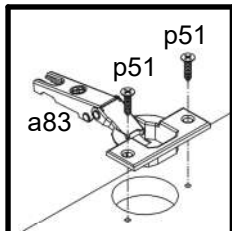
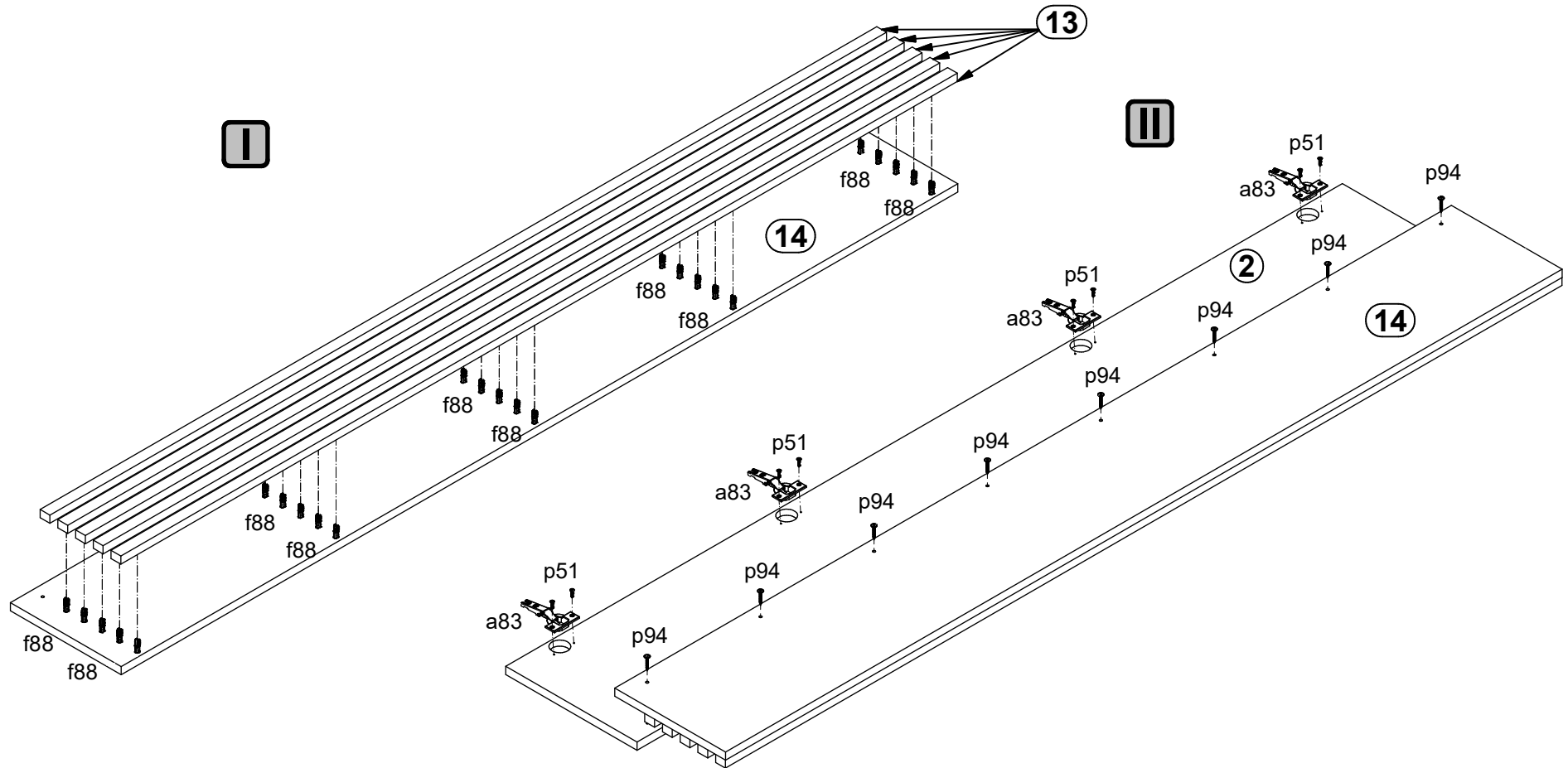
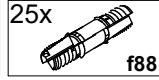
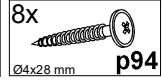
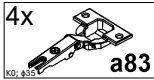



9



10



11

- 12x  **e19** Ø5x9 mm
- 12x  **f1** Ø8x30 mm
- 12x  **f25** Ø6,5x40 mm
- 6x  **o21** silikon
- 3x  **p140** Ø3,5x12 mm
- 18x  **p55** Ø2,9x16 mm
- 6x  **r15** Ø12x10,5 mm #12
- 6x  **r42** 20/11
- 3x  **t38** 450 mm
- 3x  **w24\DL** 450 mm
- 3x  **w24\DR** 450 mm



3x I

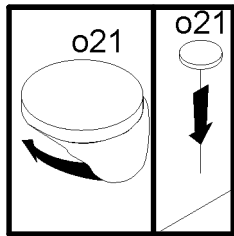
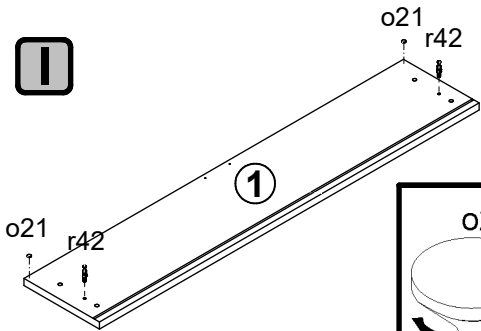
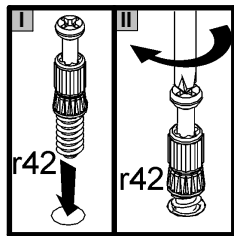

3x II

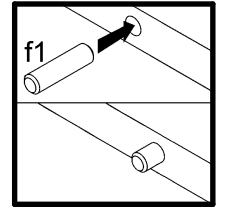
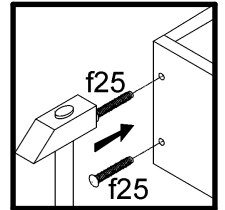
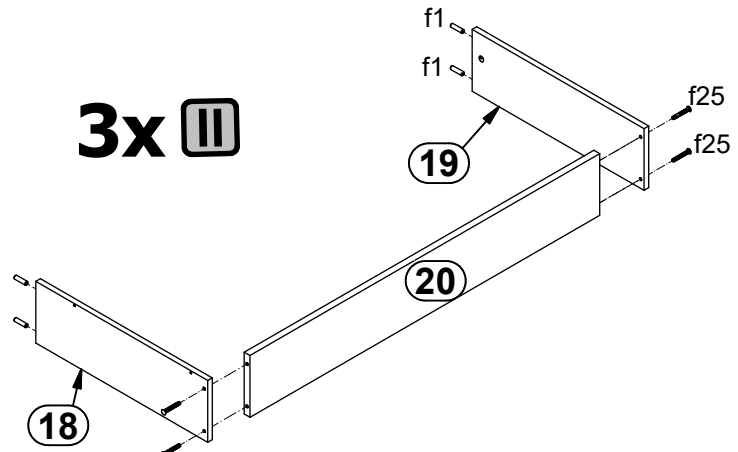

3x III

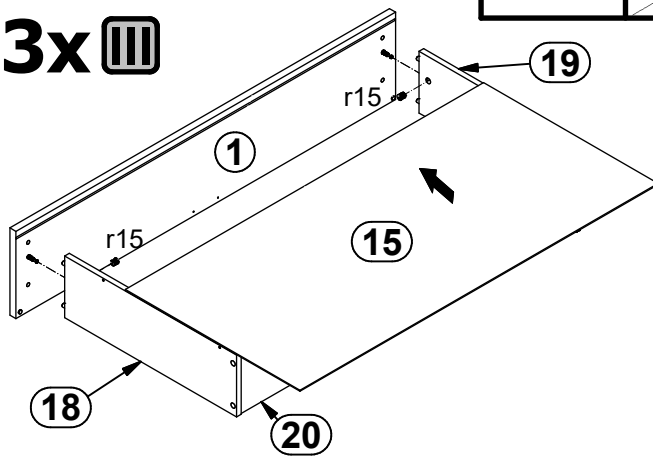

3x IV

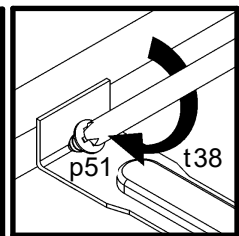
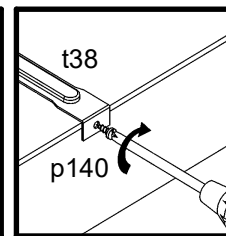
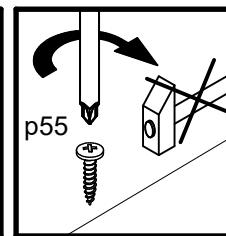
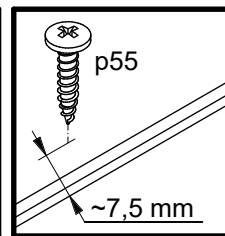
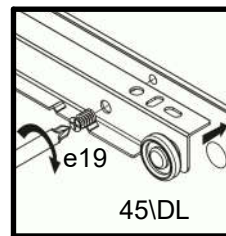
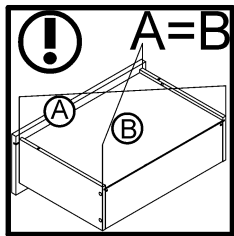
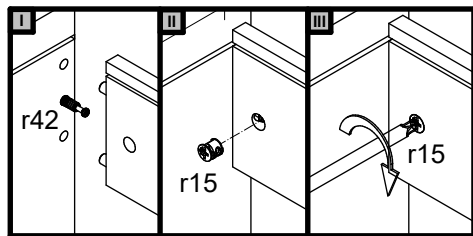
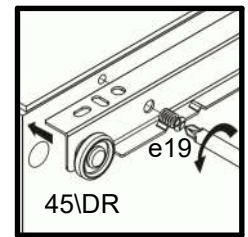
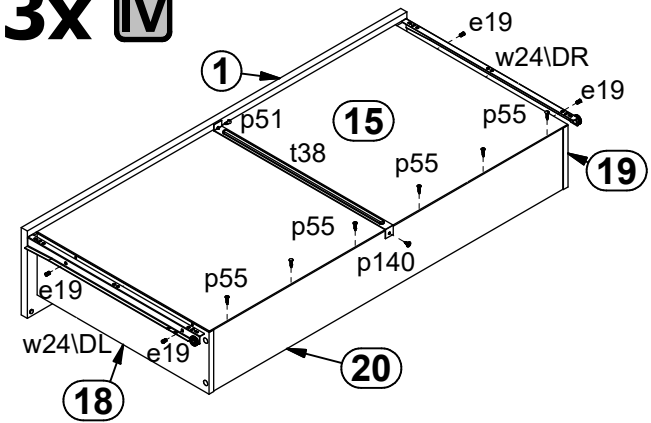

12

