

A**S620-LOZ/160****VABRES**

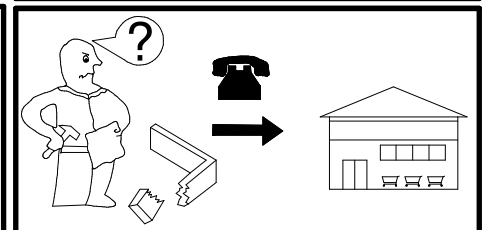

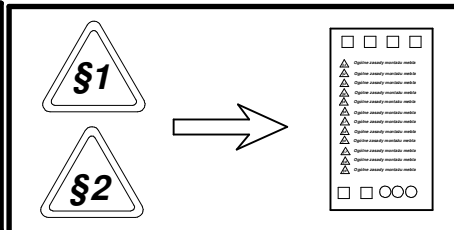

A	B1	B2	C1	C2	C3	D
1	S620-1023	-6	2000	180	22	2/2
2	S620-1024	-6	2000	180	22	2/2
3	S620-4003	-8	1232	831	28	1/2
4	S620-4004	-10	638	831	28	1/2
5	S620-4005	-10	1650	420	28	1/2
6	S620-5057	-10	420	22	16	1/2
7	S620-5058	-6	1660	36	19	1/2
9	ZZ1-431	-3	64	70	27	2/2
10	ZZ1-459	-5	205	70	27	2/2
11	ZZ1-719	-3	1983	70	27	2/2
12	ZZ1-747	-2	1880	25	25	2/2

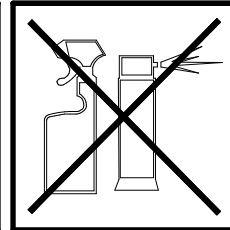
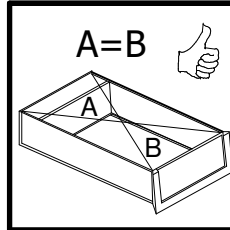
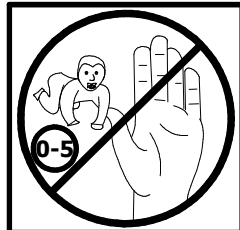
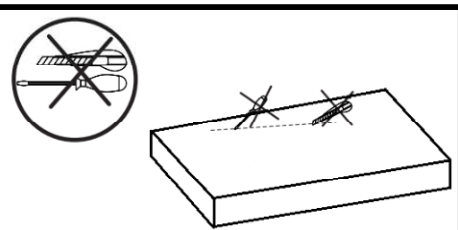
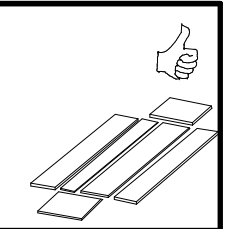
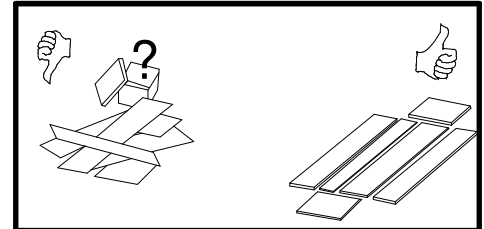
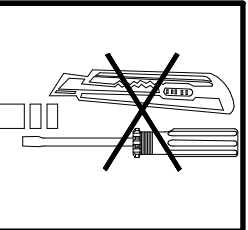
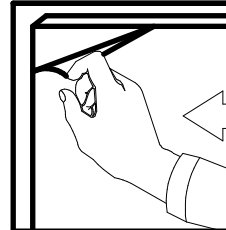
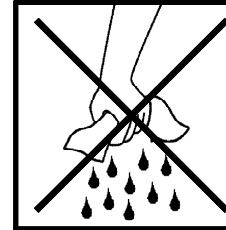
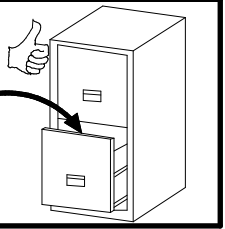
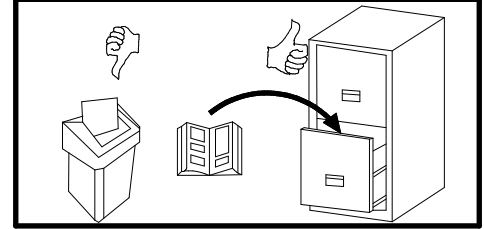
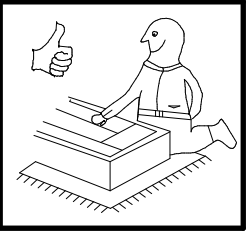
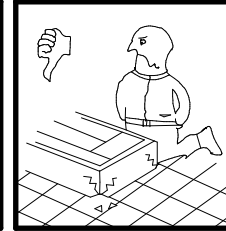
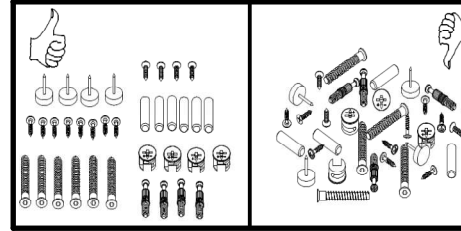
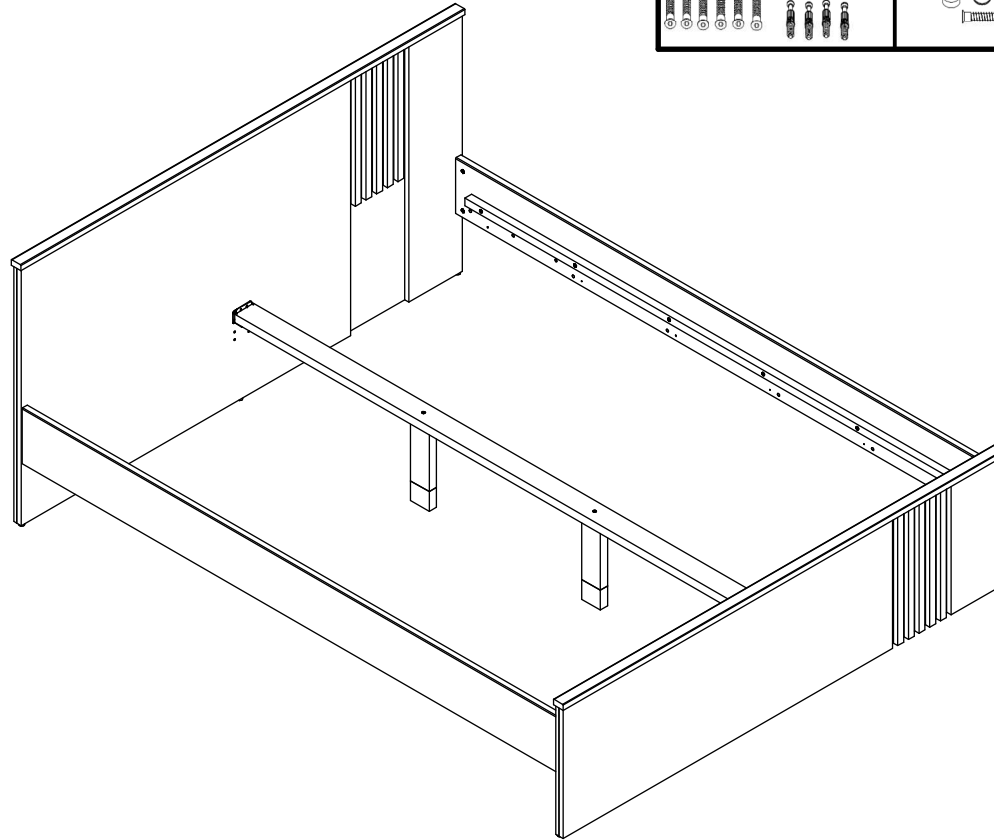
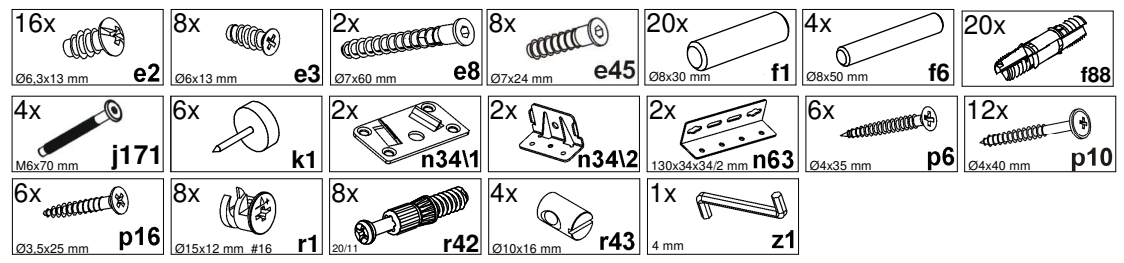
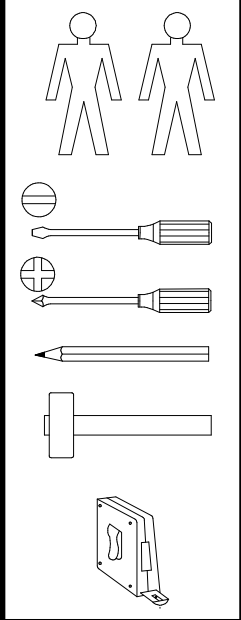
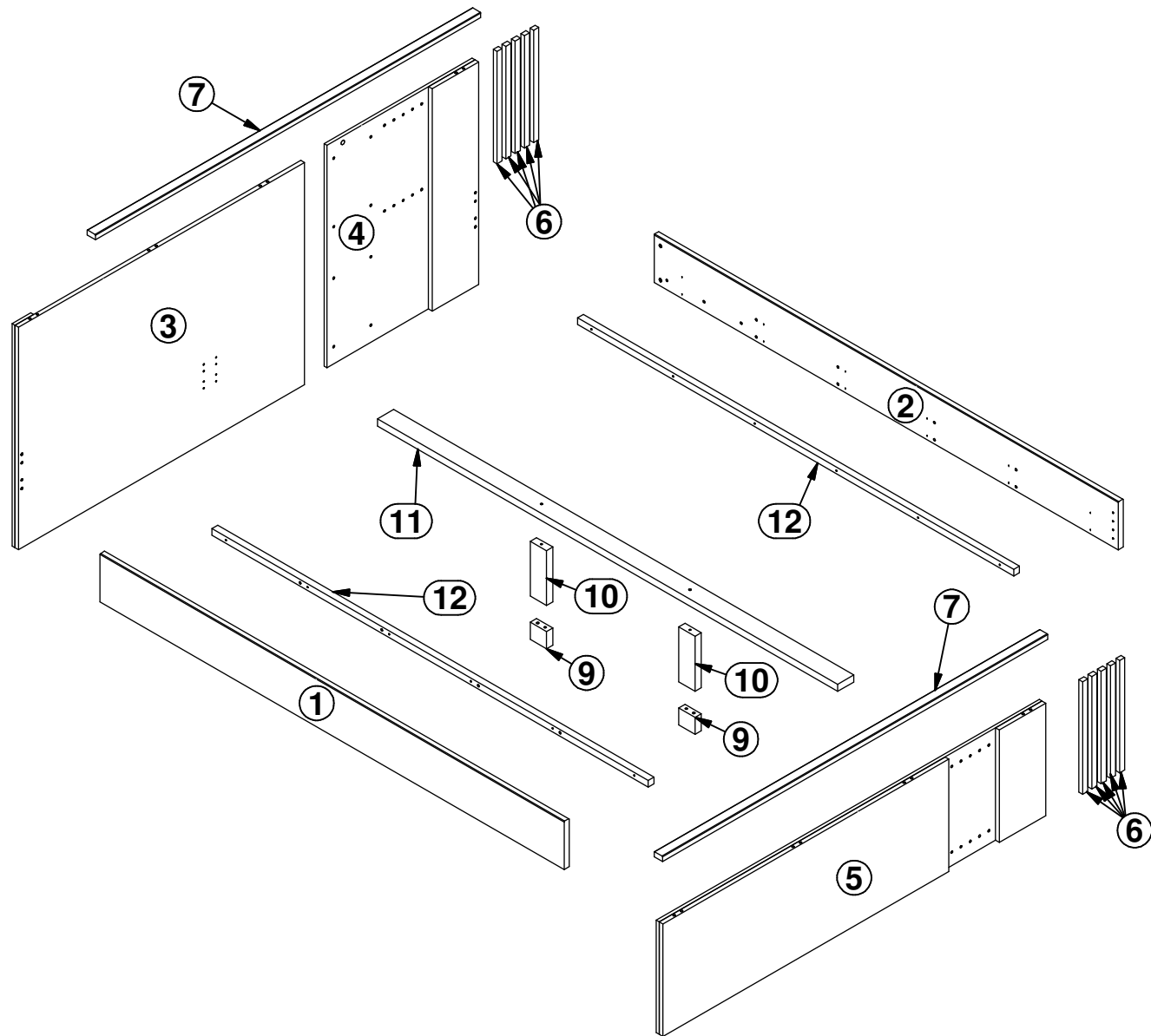

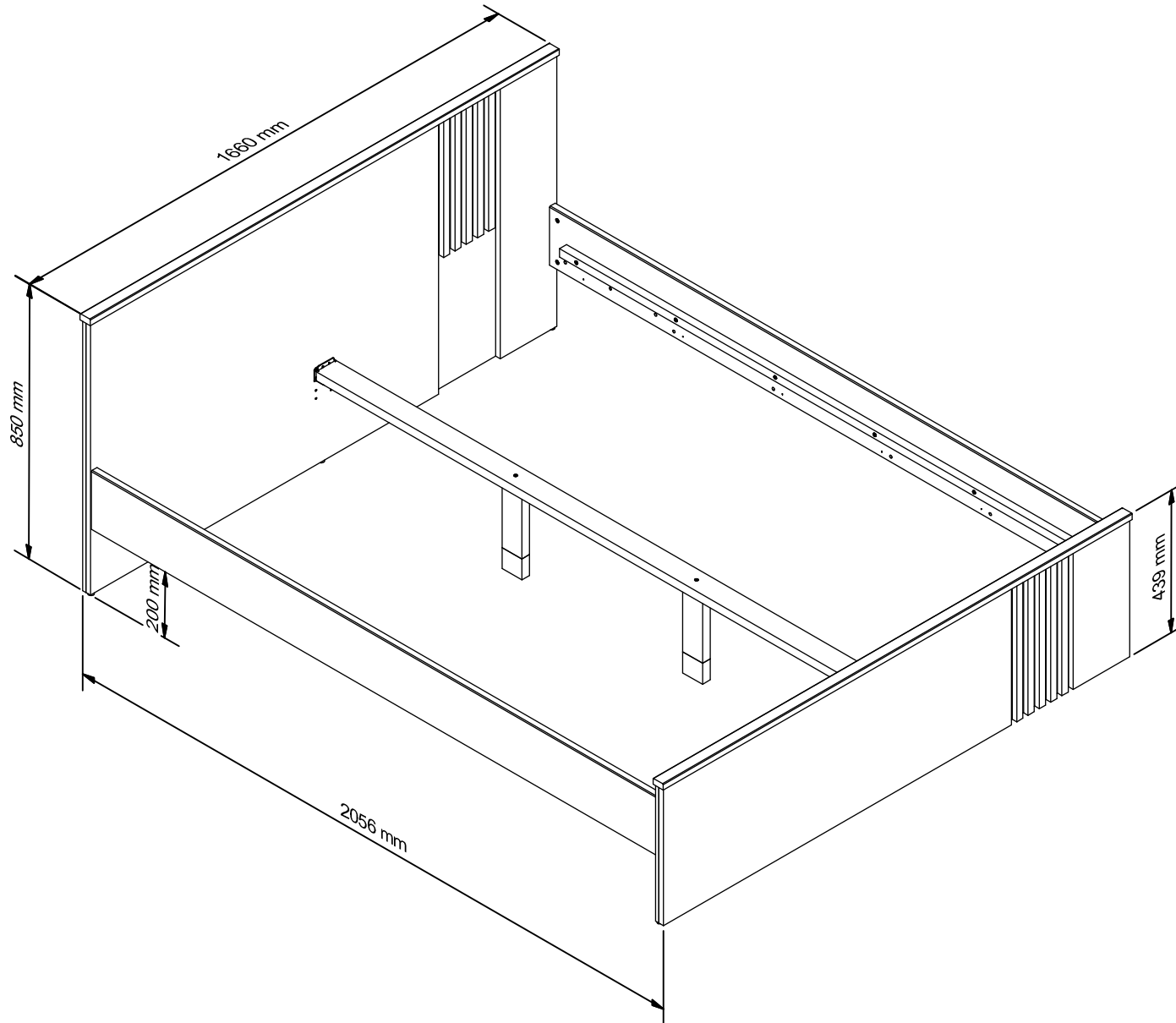



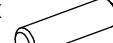



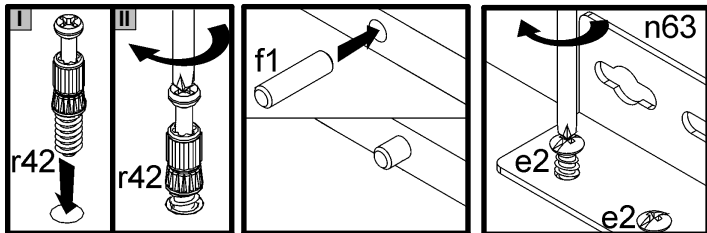
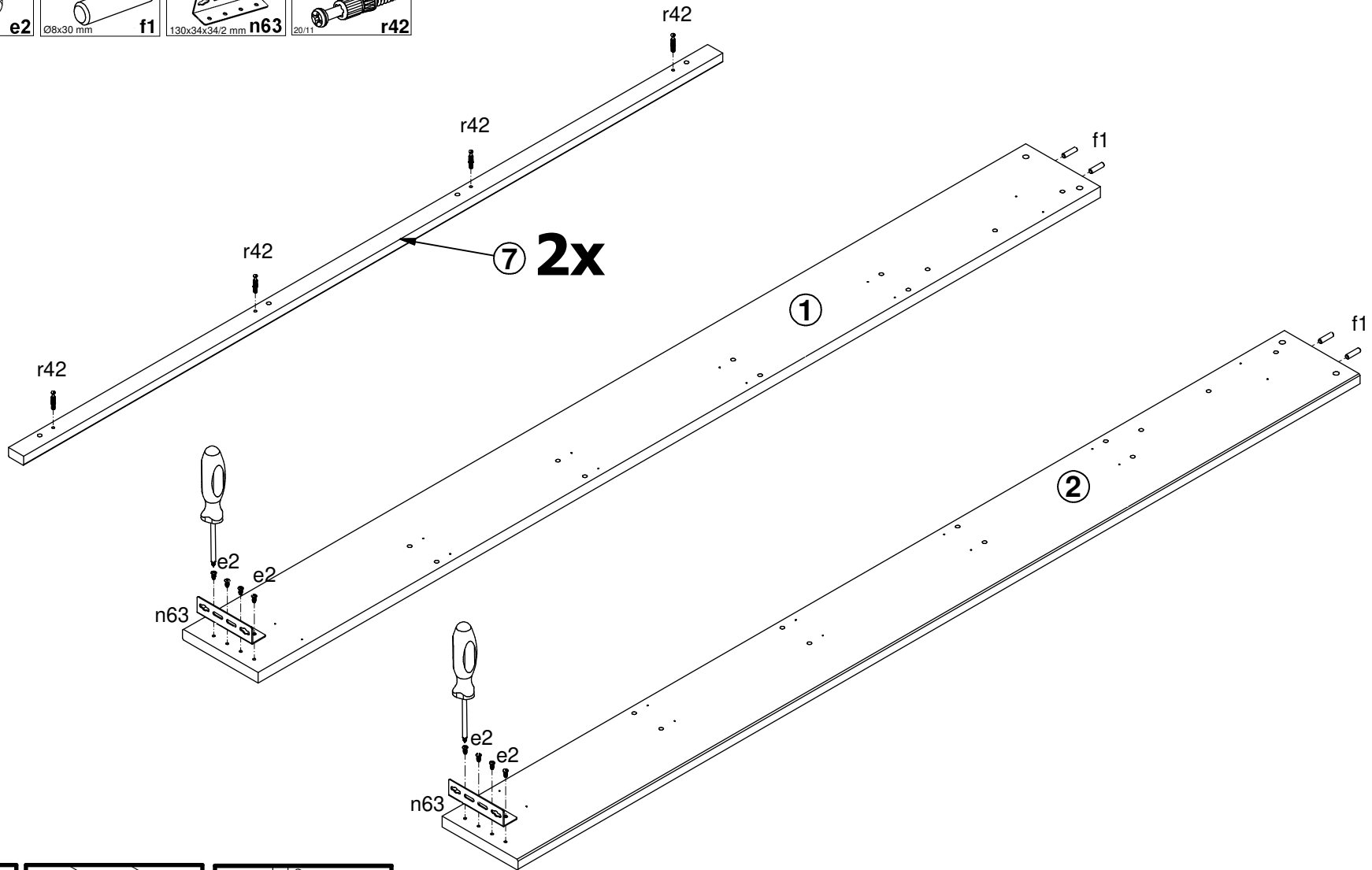

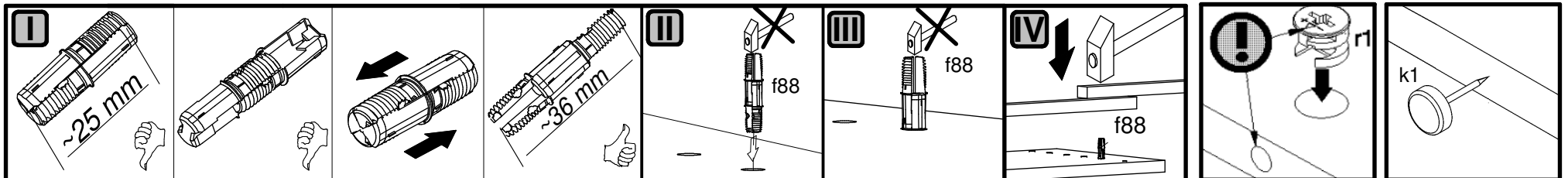
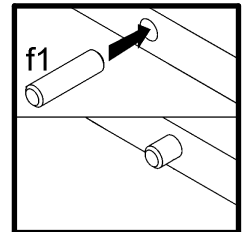
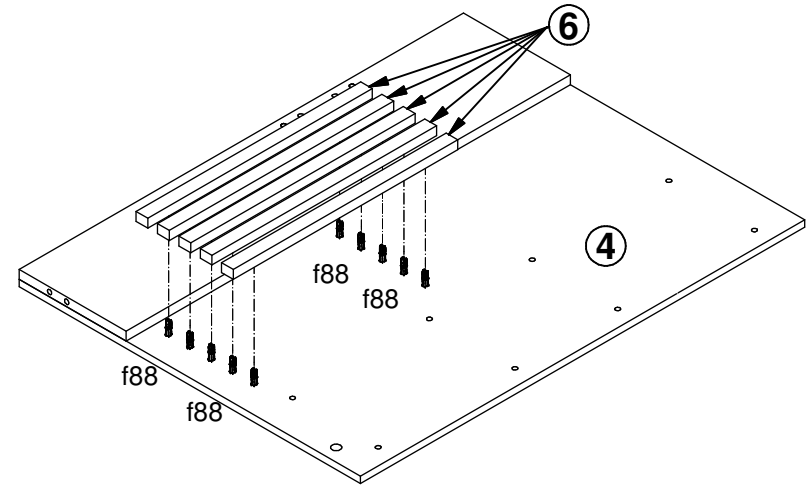
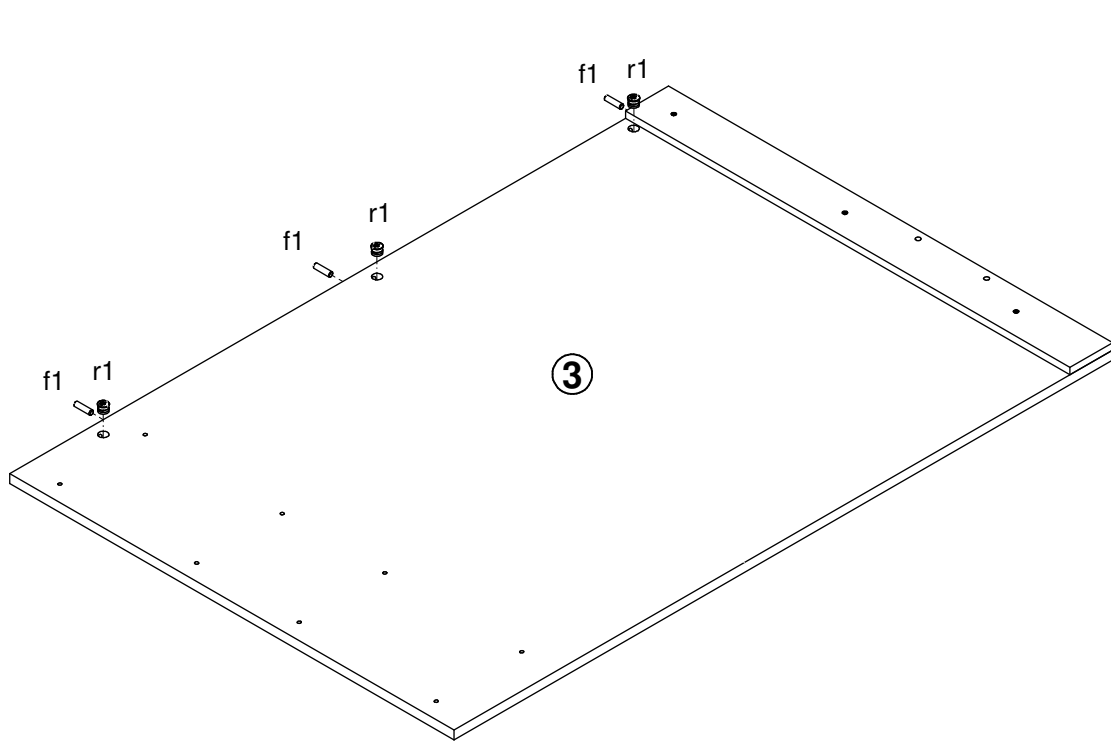
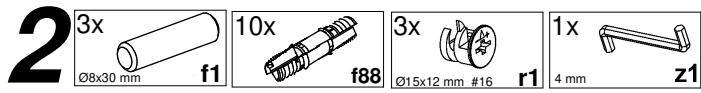
1

- 8x  e2 $\varnothing 6.3 \times 13$ mm
- 4x  f1 $\varnothing 8 \times 30$ mm
- 2x  n63 $130 \times 34 \times 34/2$ mm
- 8x  r42 $20/11$







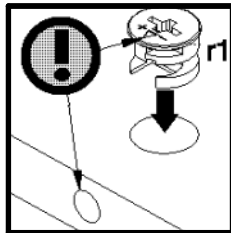
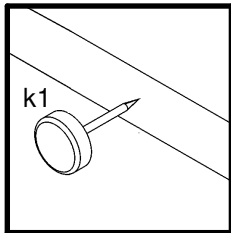
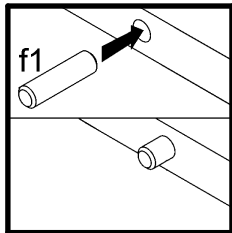
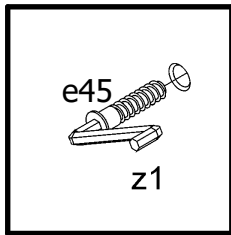
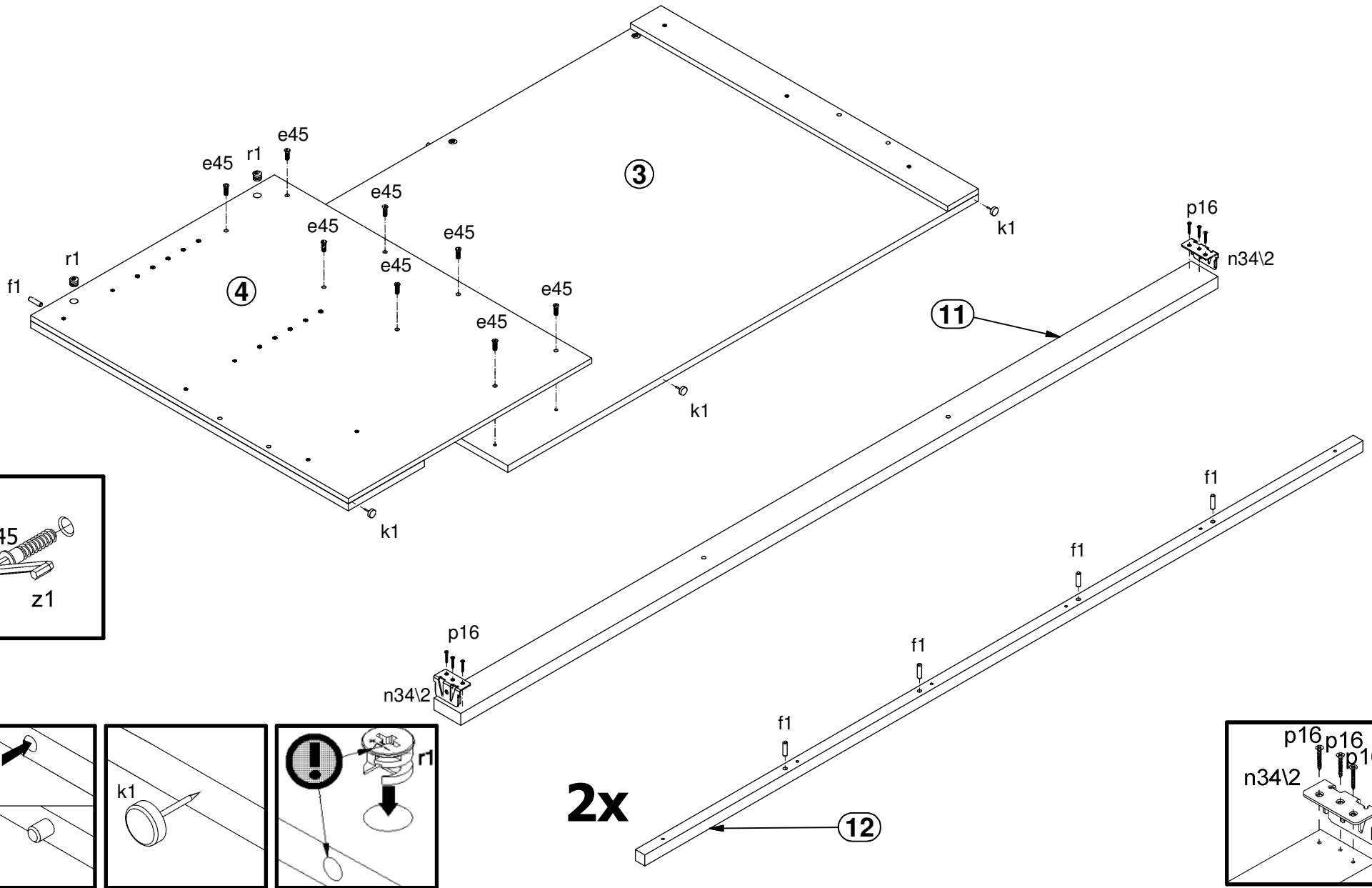

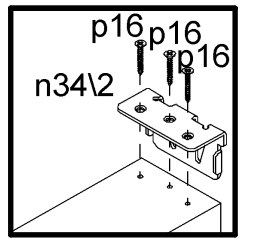

- 3 8x  e45
- 9x  f1
- 3x  k1
- 2x  n34\2
- 6x  p16
- 4x  r1



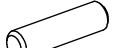



2x

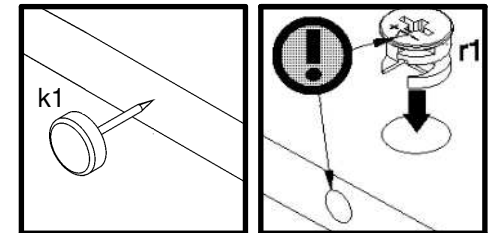
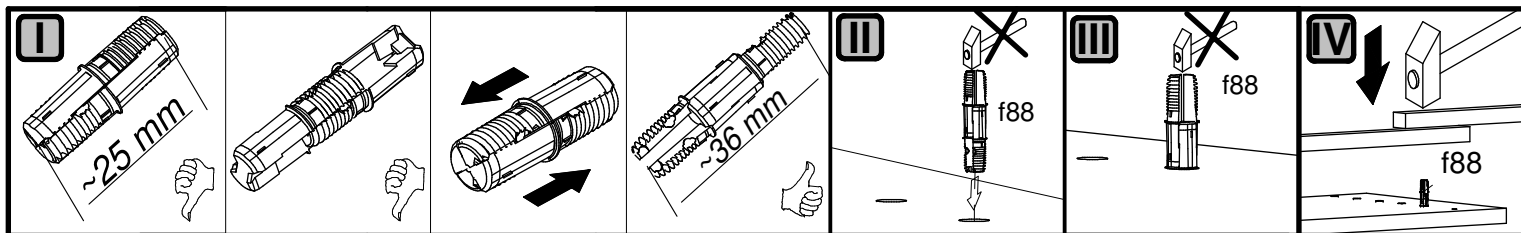
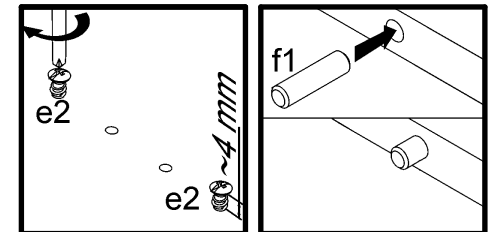
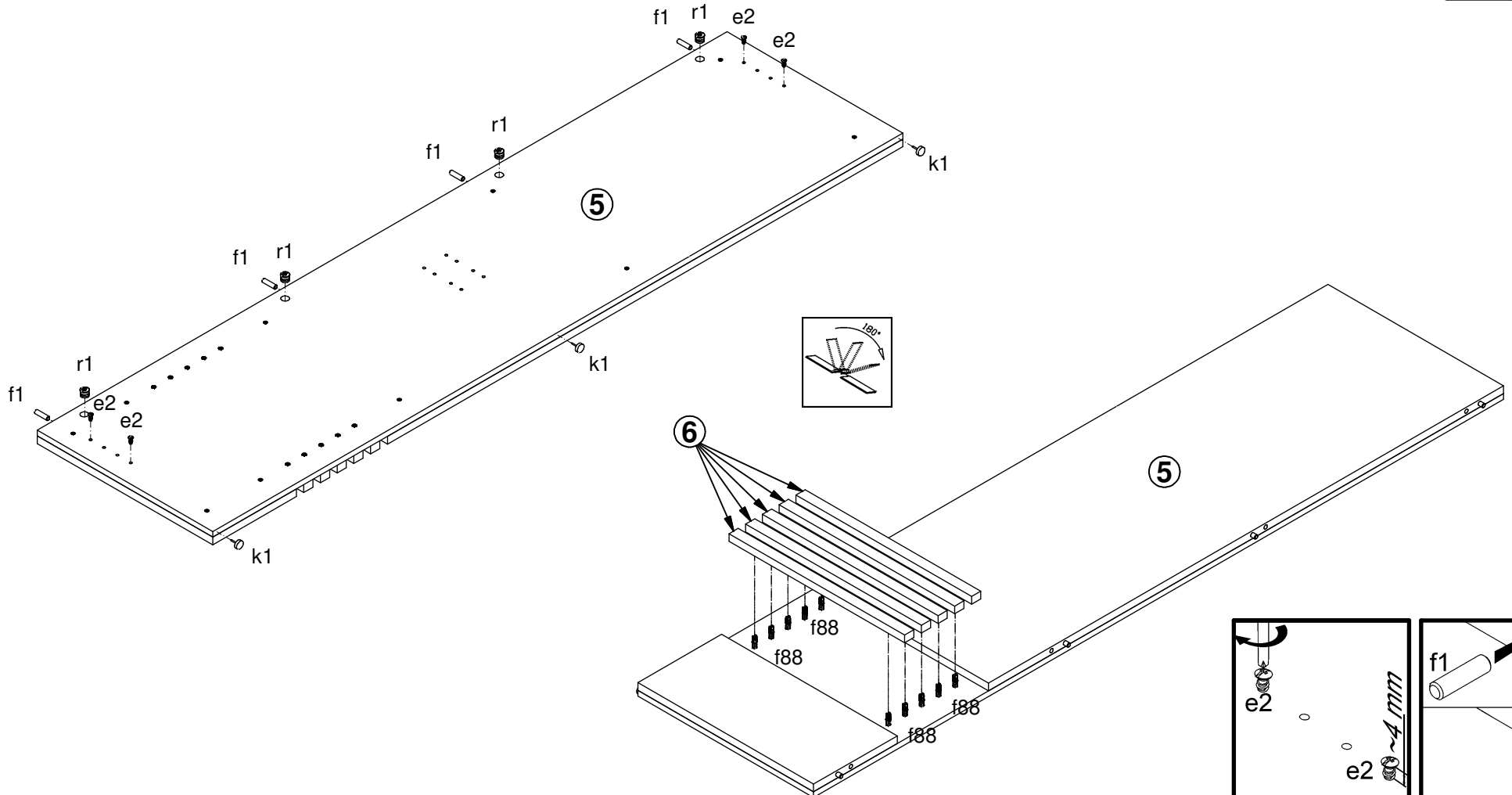

- 4** 4x  e2 $\varnothing 6,3 \times 13 \text{ mm}$
- 4x  f1 $\varnothing 6 \times 30 \text{ mm}$
- 3x  k1
- 4x  r1 $\varnothing 15 \times 12 \text{ mm} \# 16$
- 10x  f88



- 5** 4x  e2 $\varnothing 6,3 \times 13$ mm
4x  j171 M6x70 mm
4x  r43 $\varnothing 10 \times 16$ mm
1x  z1 4 mm

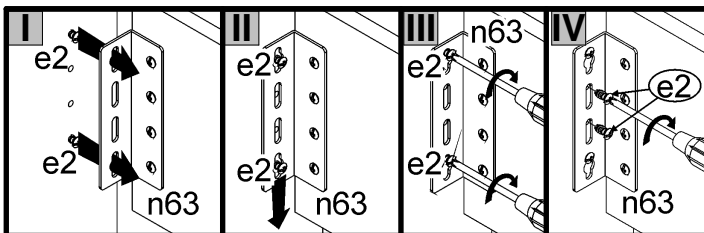
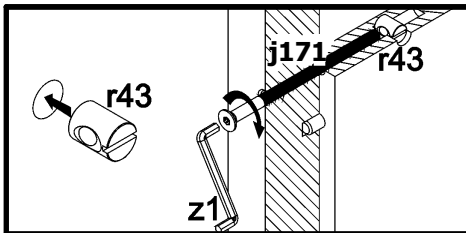
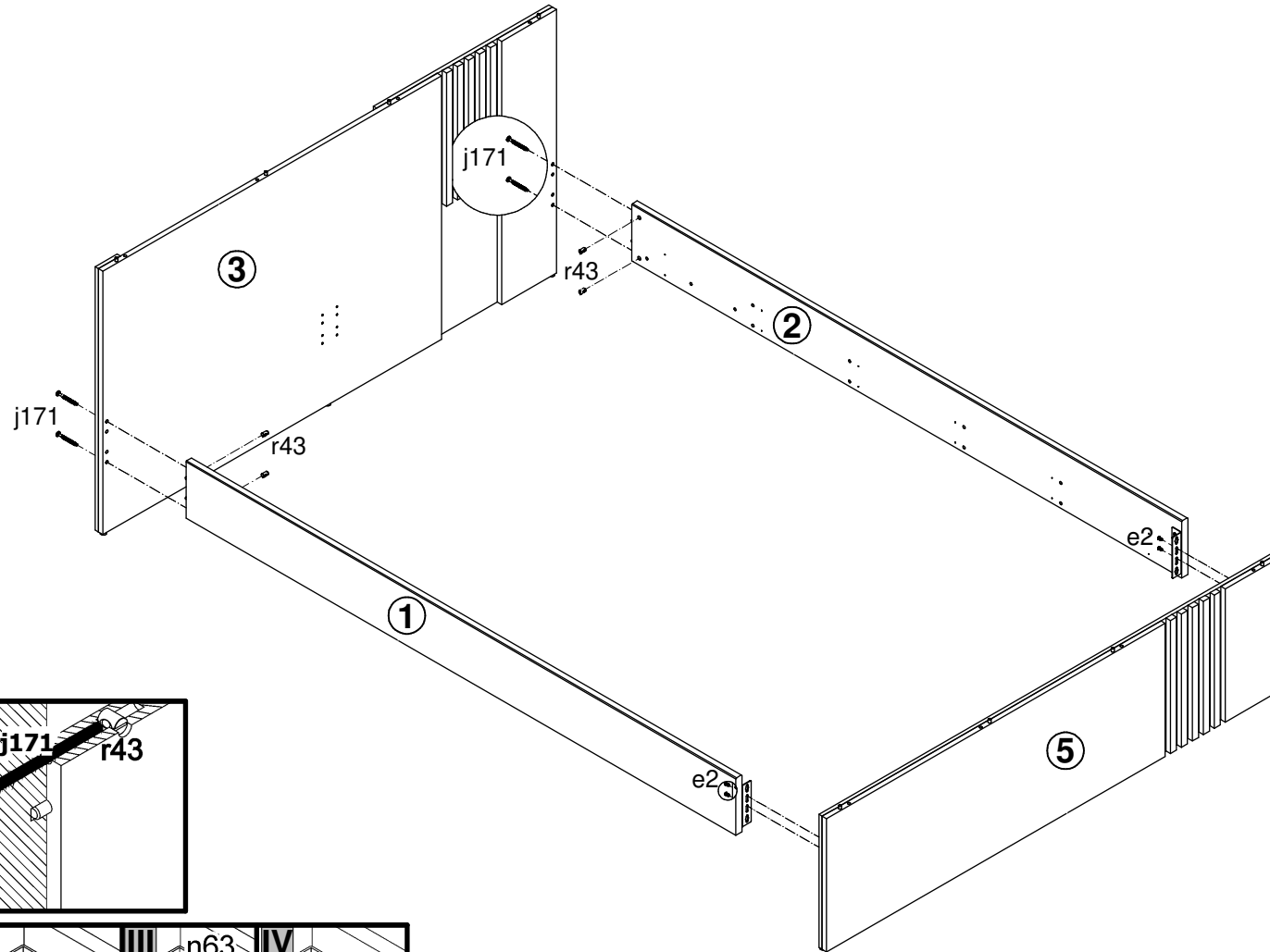

6A

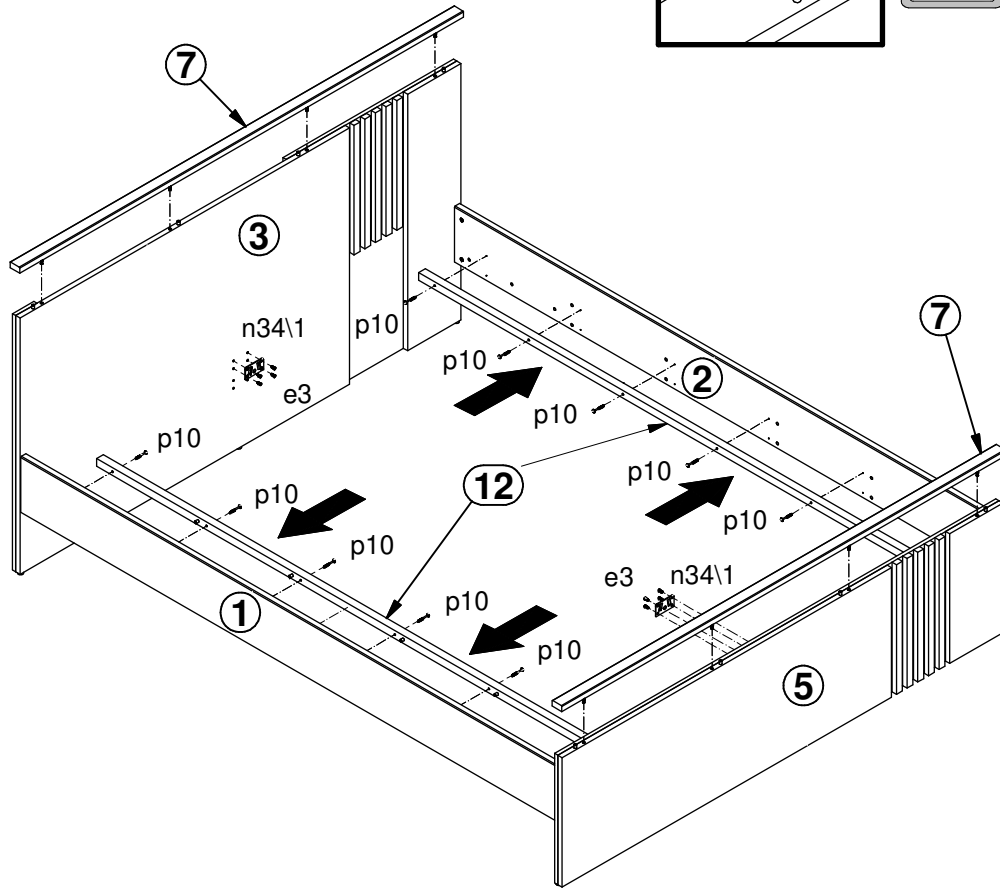
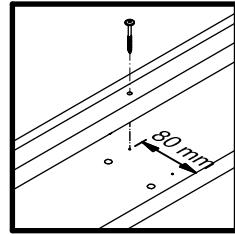
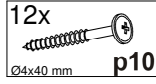
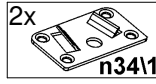
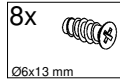

6B

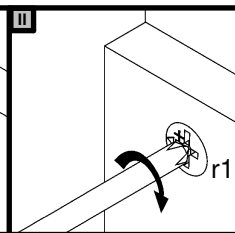
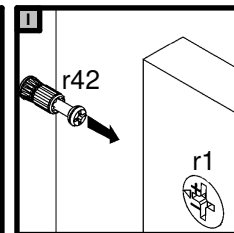
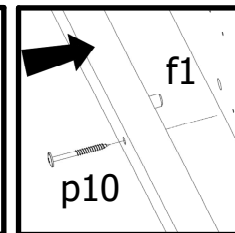
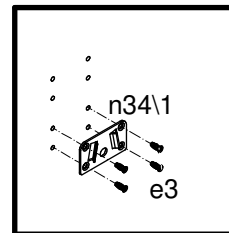
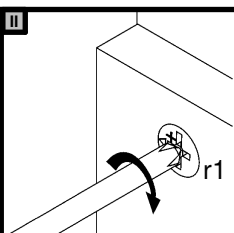
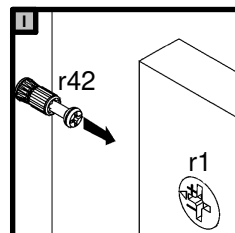
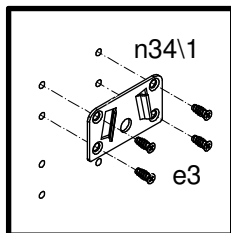
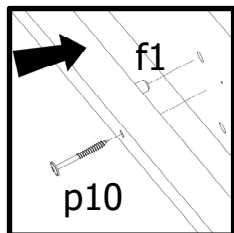
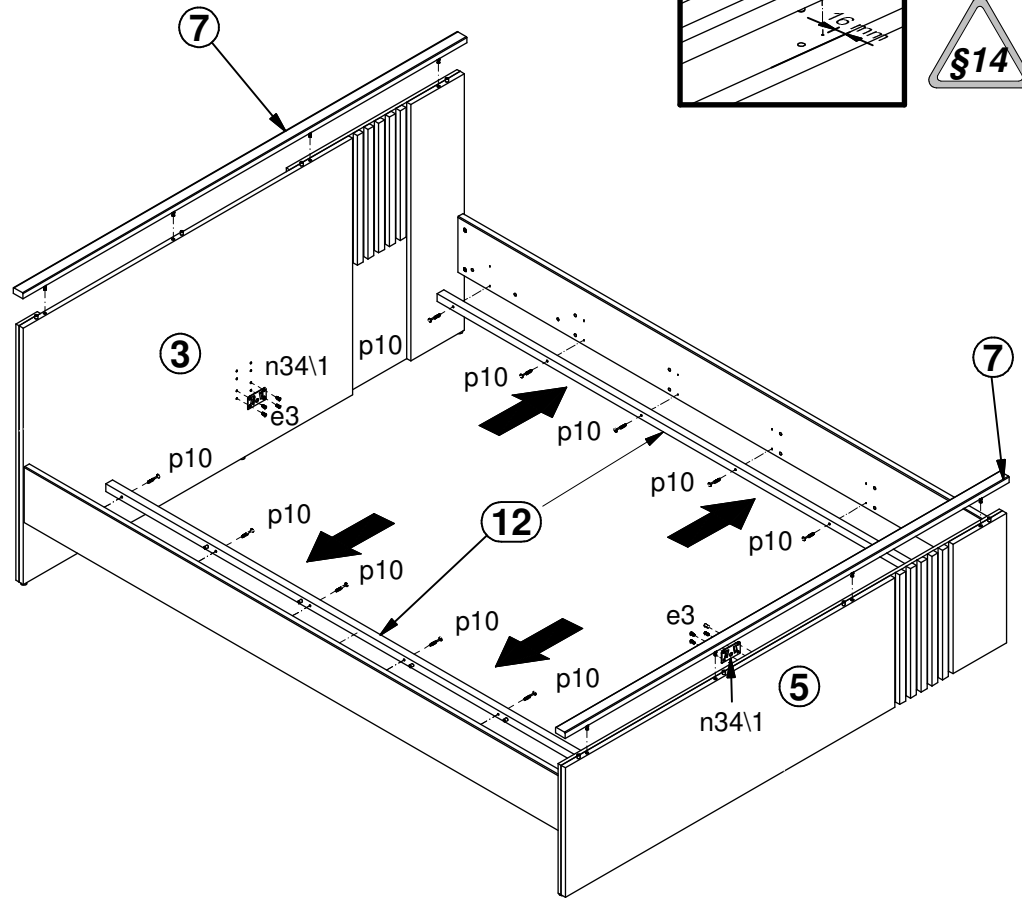
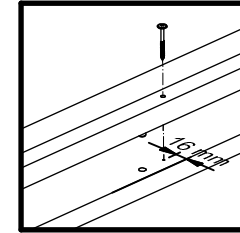
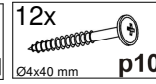
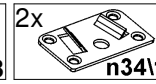
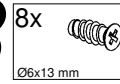

7A

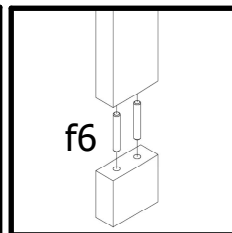
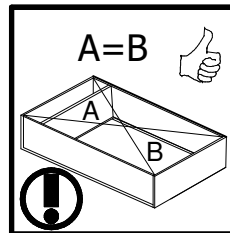
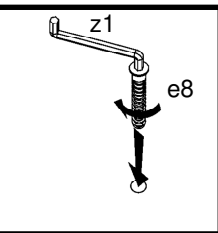
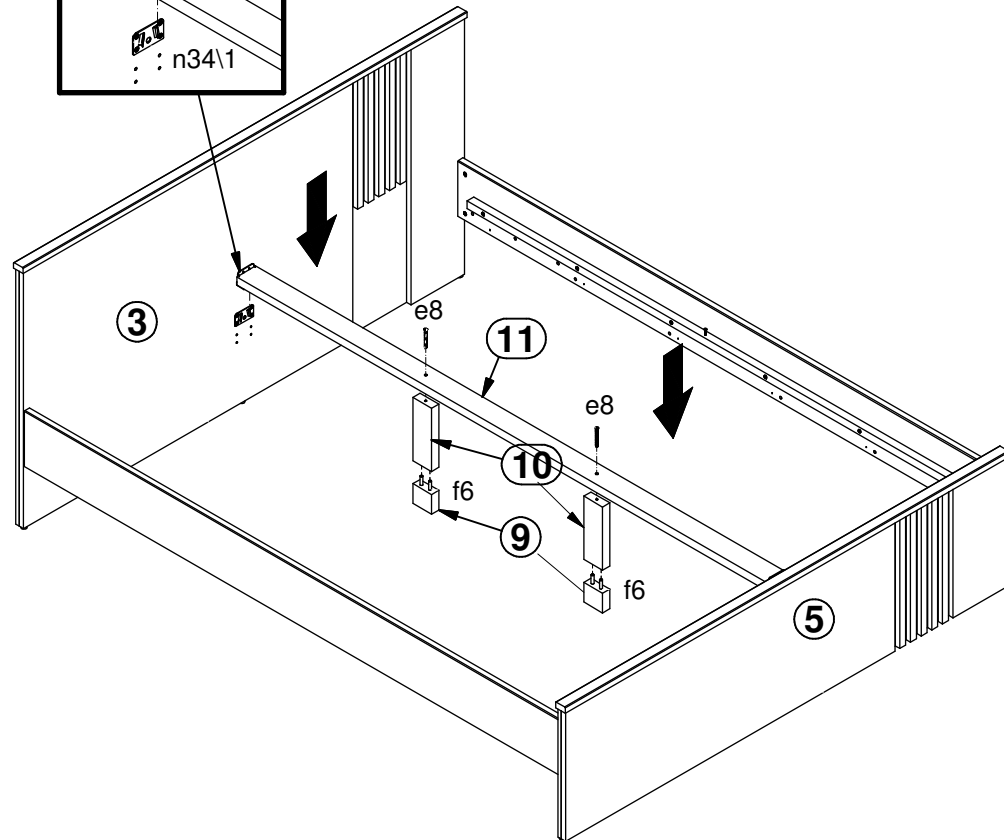
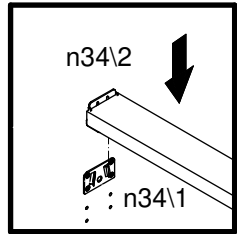
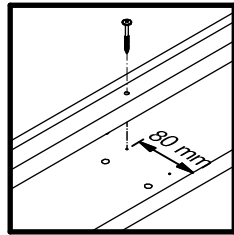
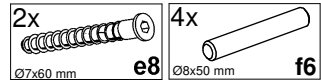

7B

