

SALGA

S615-SZF3D

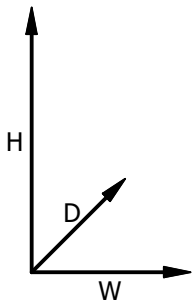

H - 2023 mm
W - 1590 mm
D - 545 mm

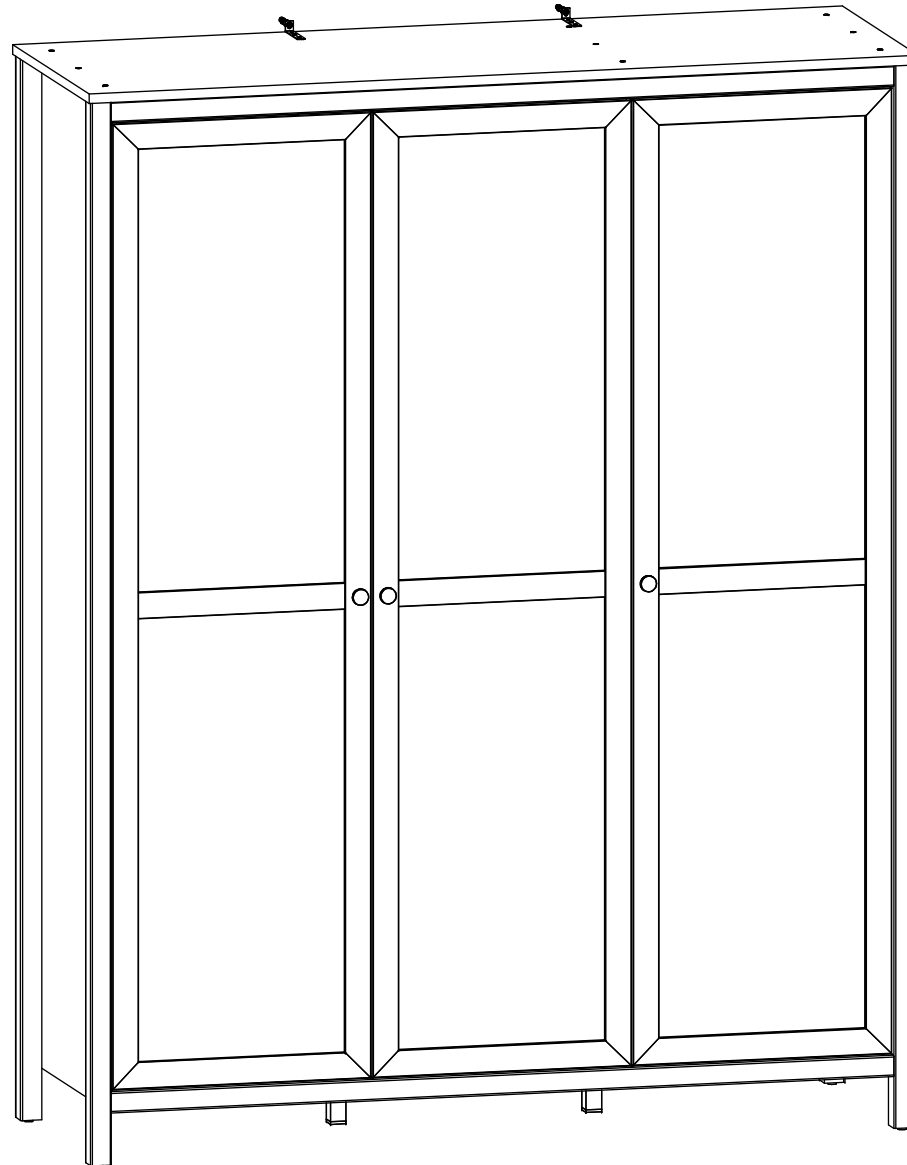
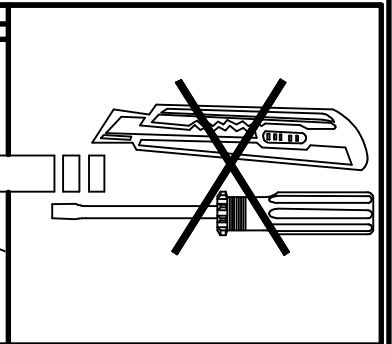
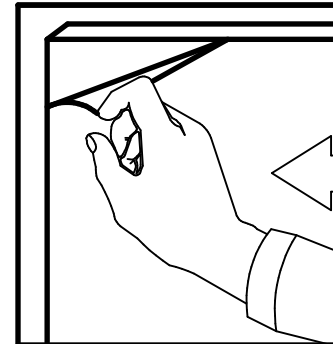
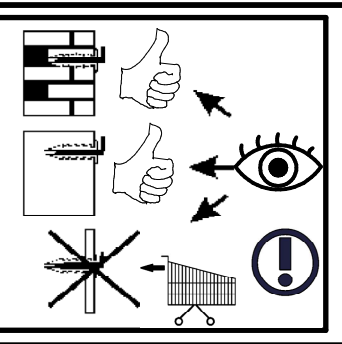
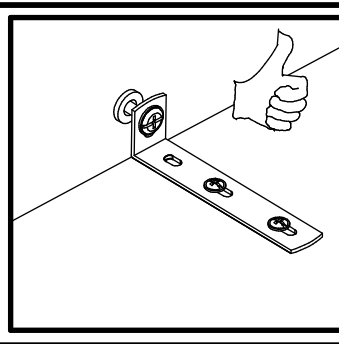
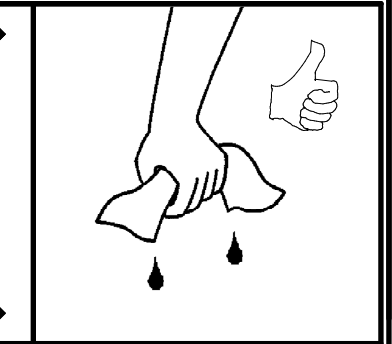
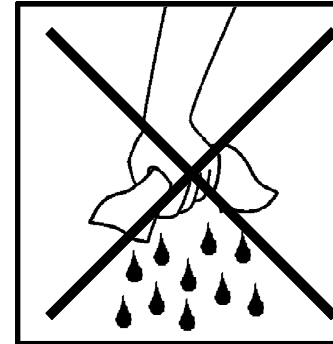
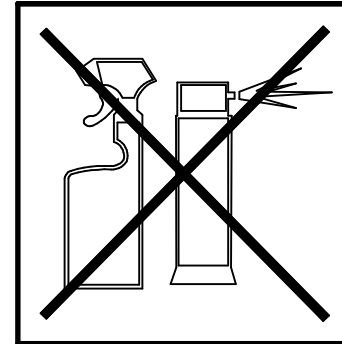
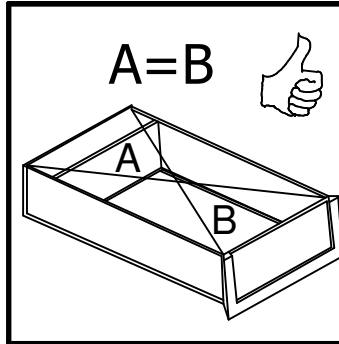
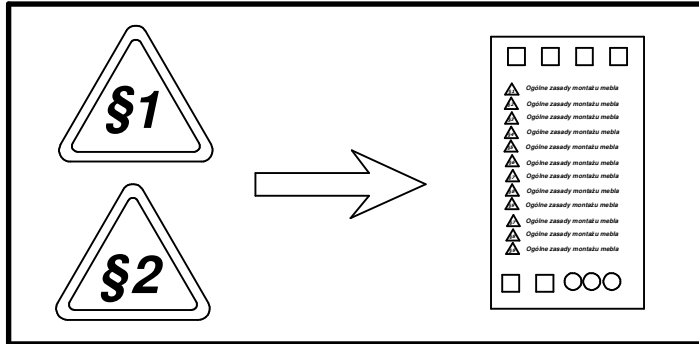
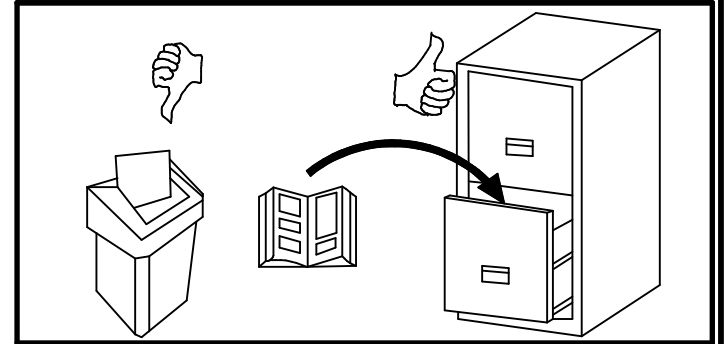
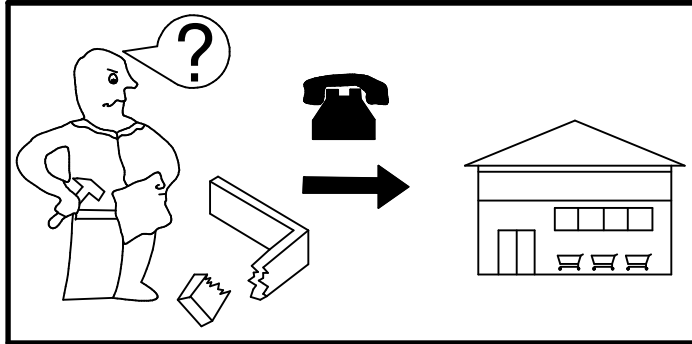
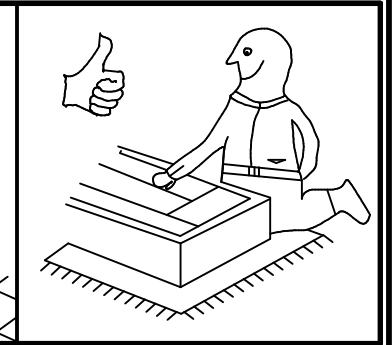
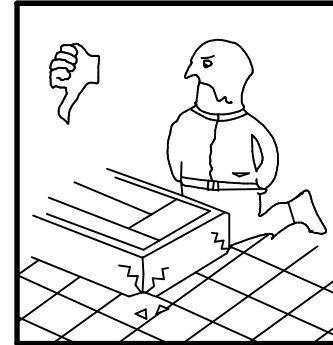
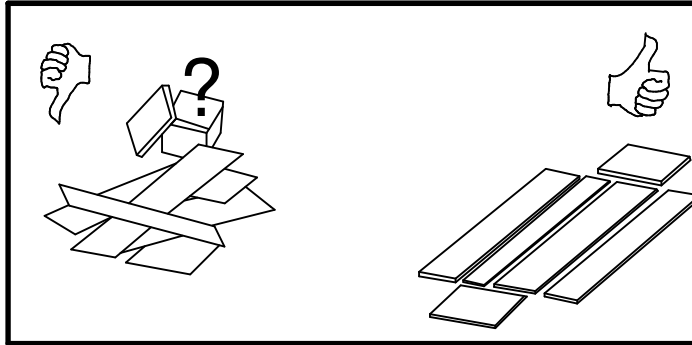
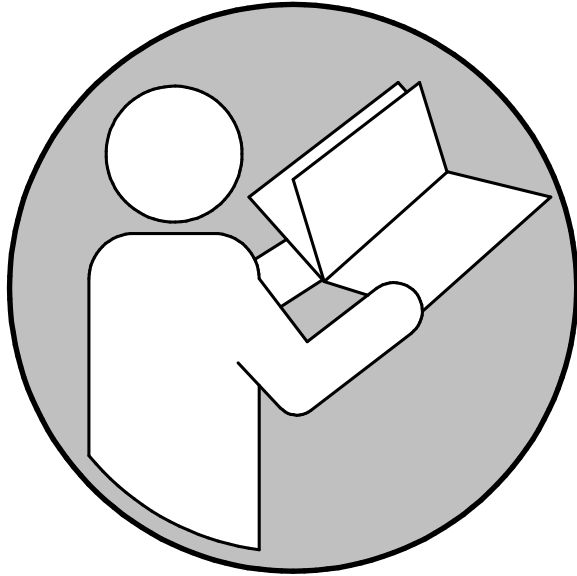

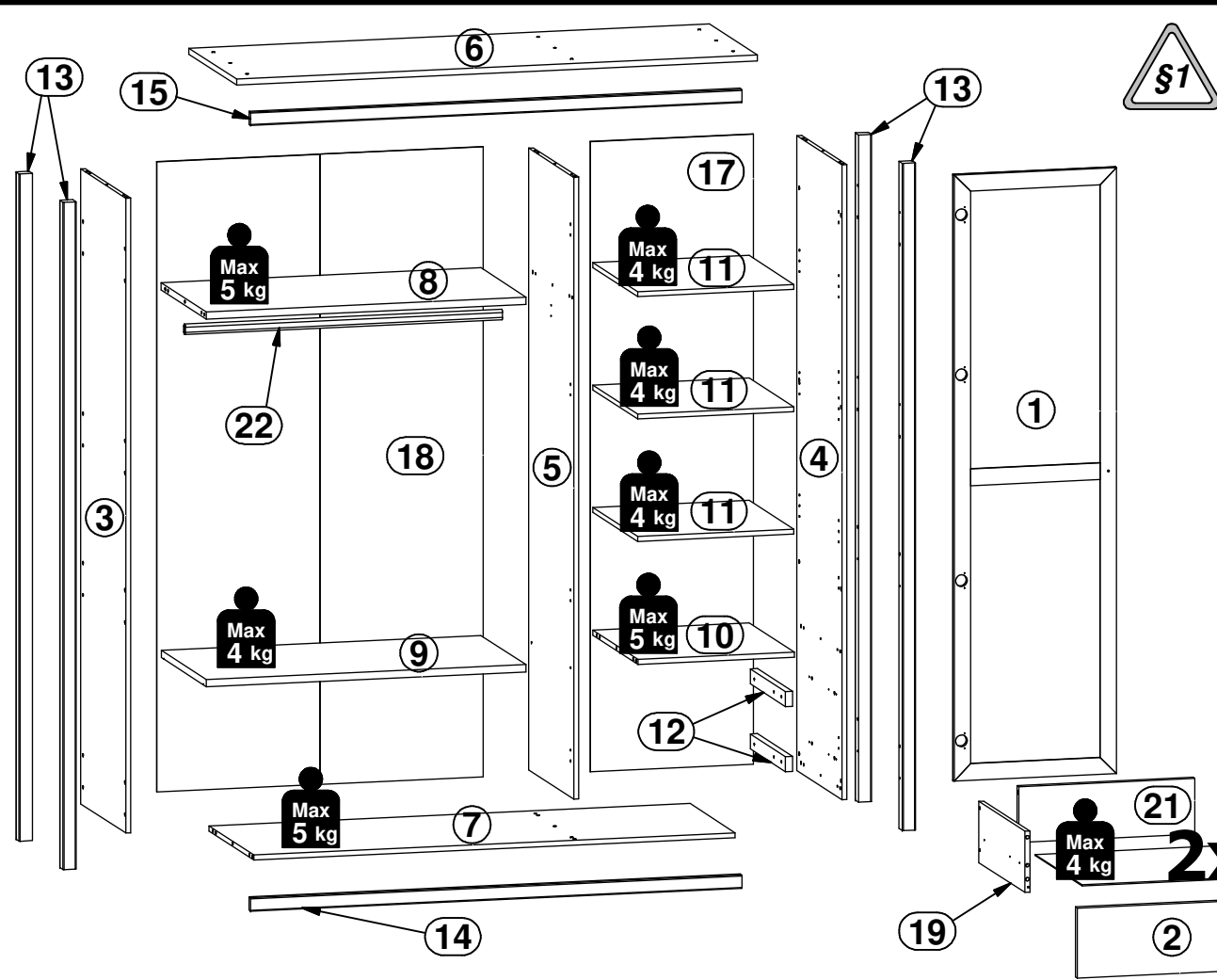
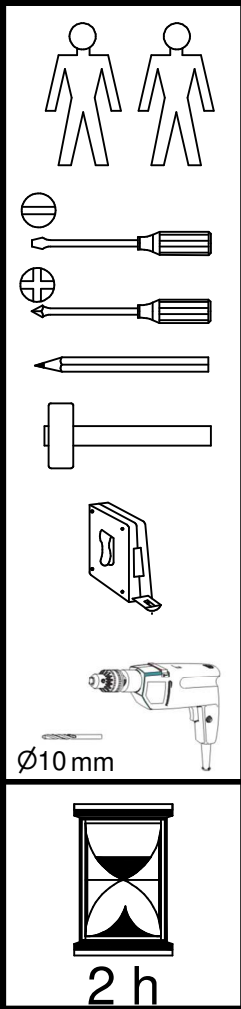

A	B	C (mm)			D
1	S615-0007	1817	496	16	1/5
2	S615-0008	446	160	15	5/5
3	S615-1011	1903	514	15	2/5
4	S615-1012	1903	514	15	2/5
5	S615-1013	1864	514	15	3/5
6	S615-2004	1590	545	18	2/5
7	S615-3007	1470	514	15	3/5
8	S615-3008	977	514	22	5/5
9	S615-3009	976	514	22	5/5
10	S615-3010	478	514	15	5/5
11	S615-3011	477	510	15	5/5
12	S615-4018	400	45	22	5/5
13	S615-5020	2000	40	40	4/5
14	S615-5022	1500	40	19	4/5
15	S615-5023	1500	40	19	4/5
16	S615-9010	420	407	2,5	3/5
17	S615-9011	1889	498	2,5	3/5
18	S615-9302	1889	997	2,5	3/5
19	WSK3-5007	400	140	12	5/5
20	WSK3-5008	400	140	12	5/5
21	STK-5006	410	127	15	5/5
22	dr-969	969	30	15	5/5

8x a83	4x a173	8x b32	4x b42	cm 0 1 2 3 4 5 6 7 8 9 10							3x c601	16x d1 Ø5x17 mm	6x d41/2	<table border="1"><tr><th>D</th></tr><tr><td>5/5</td></tr></table>	D	5/5
D																
5/5																
12x e1 Ø7x50 mm	16x e11 Ø7x40 mm	48x f1 Ø8x30 mm	8x f25 Ø6,5x40 mm	2x f35 Ø10x50 mm	3x j1 M4x20 mm	4x k1	2x k38/3 42,5x42,5x4 mm	2x k38/7 30x30x108 mm	70x l1 1,4x20 mm	9x n108 22x9,5x2/0,7 mm	2x n142 86x21x15/1,5	2x n267				
6x o21 silikon	18x p140 Ø3,5x12 mm	2x p17 Ø5x60 mm	6x p26 Ø4x35 mm	38x p38 Ø3,5x16 mm	32x p51 Ø3,5x15 mm	18x p55 Ø2,9x16 mm	18x r1 Ø15x12 mm #16	4x r15 Ø12x10,5 mm #12	22x r42 20/11	6x s68 Ø 20mm	14x s59 Ø14x0,5 mm	4x w154/1 400/670 mm				
4x w154/2 400/670 mm	1x z1 4 mm															

1  

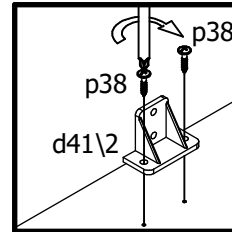

I

I

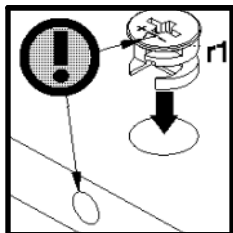
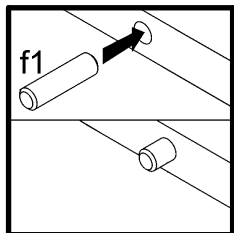
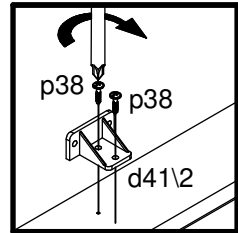
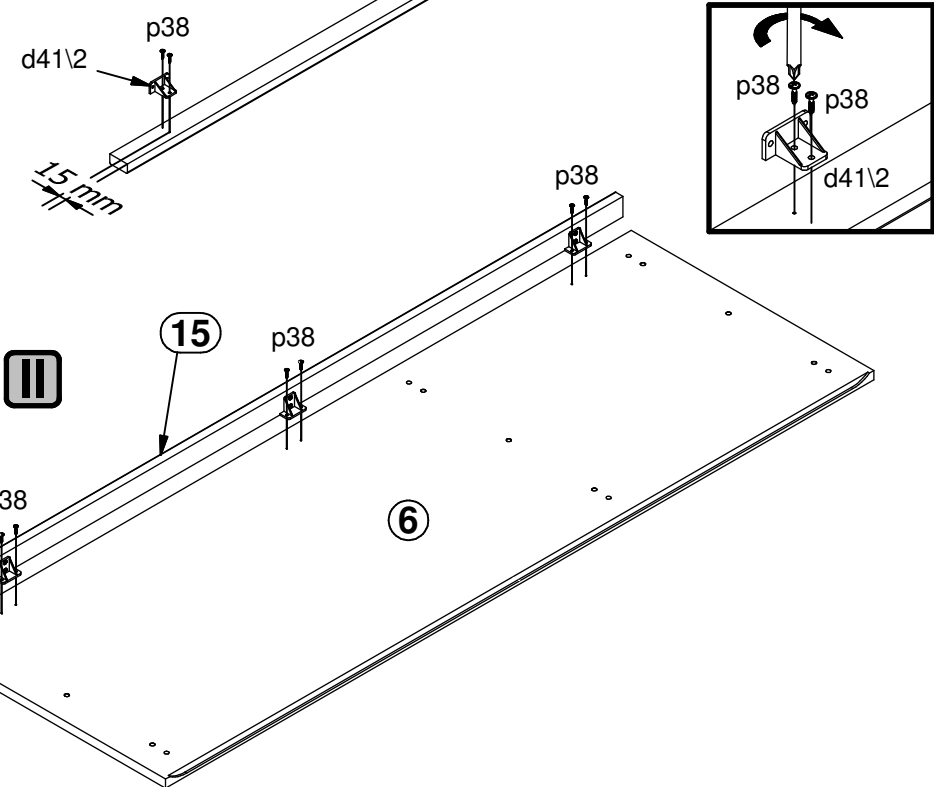
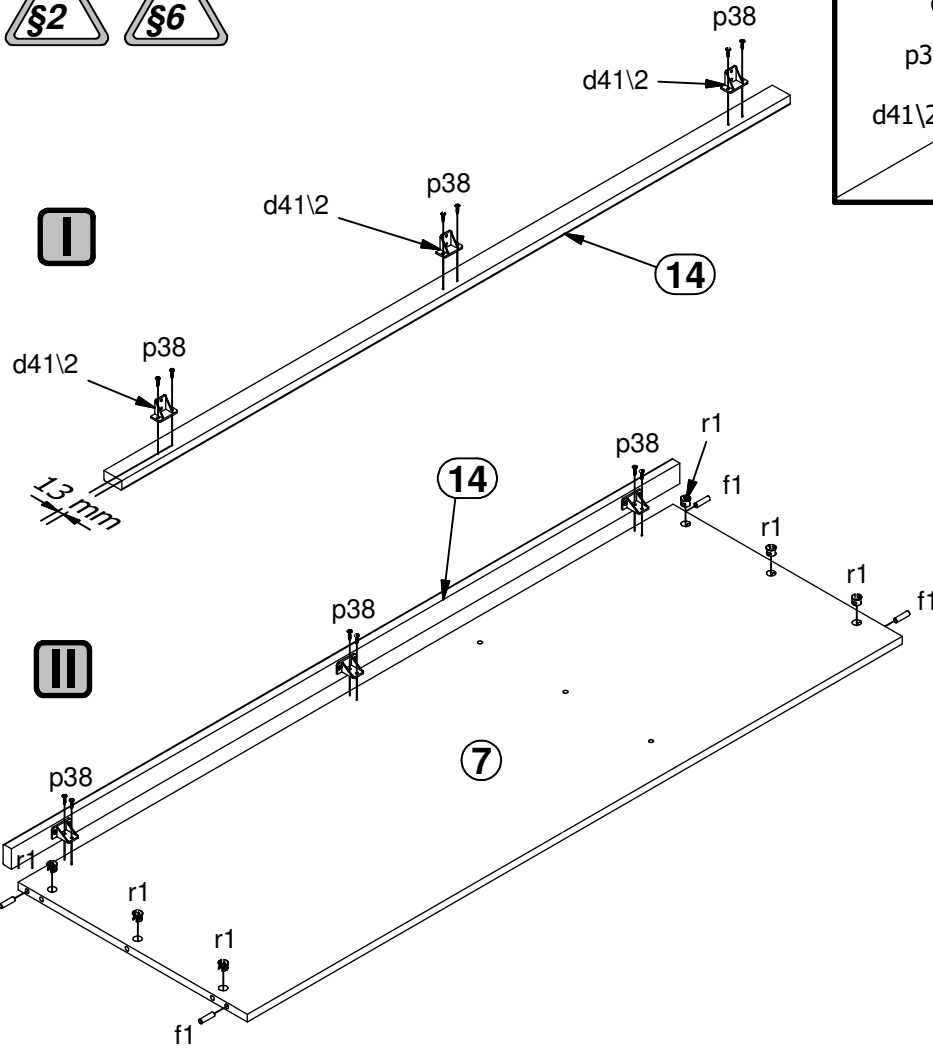

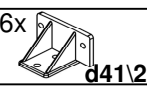
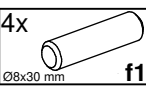
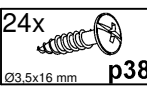
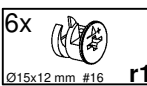



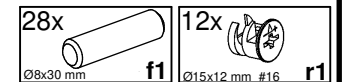
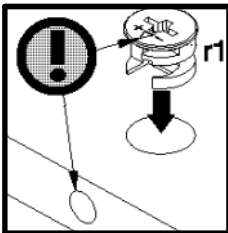
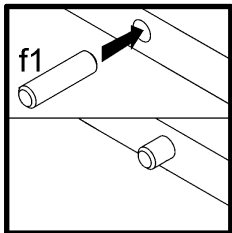
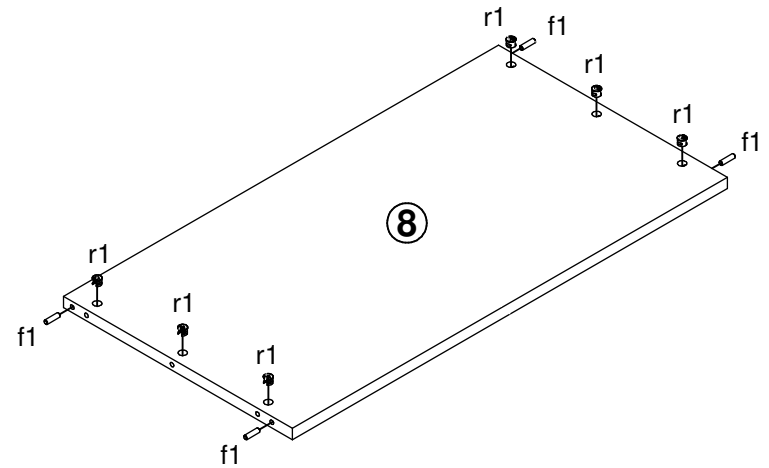
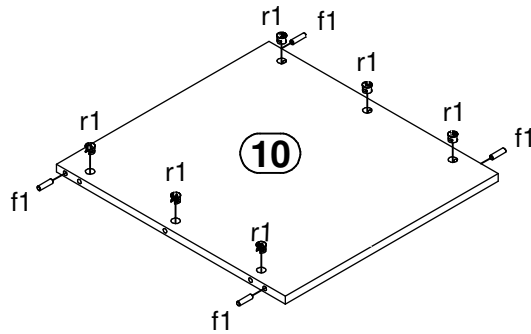
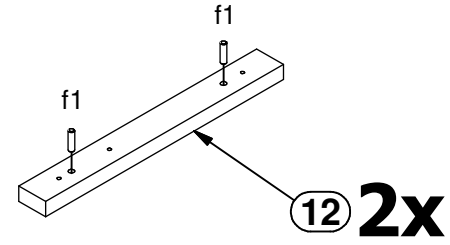
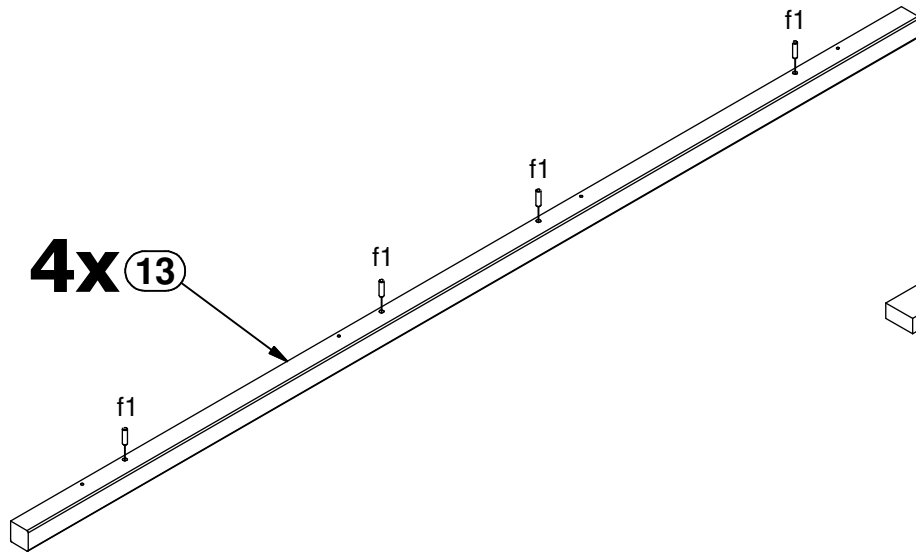

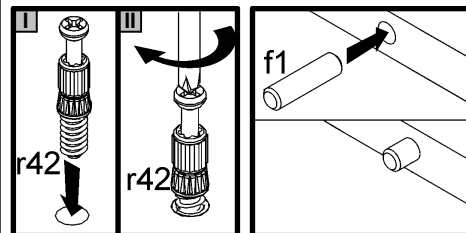
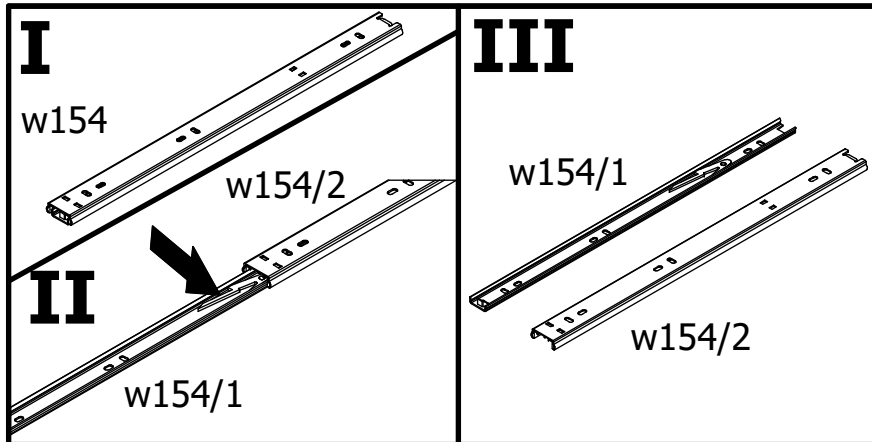
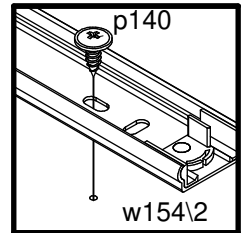
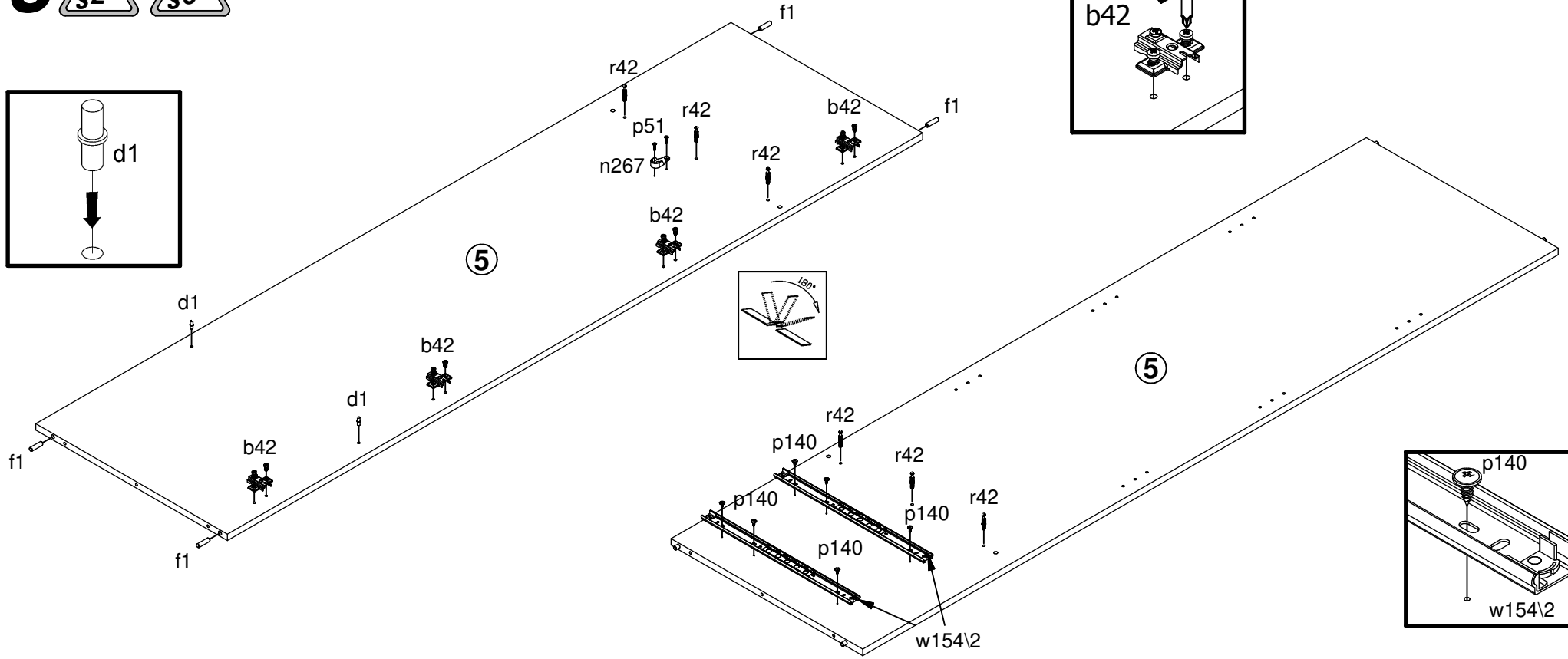
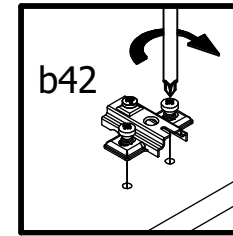
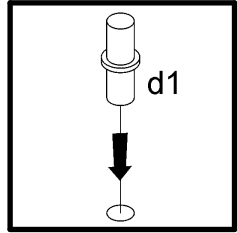

- 
6x **d41/2**
- 
4x **f1**
Ø8x30 mm
- 
24x **p38**
Ø3.5x16 mm
- 
6x **r1**
Ø15x12 mm #16

2 

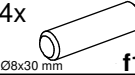





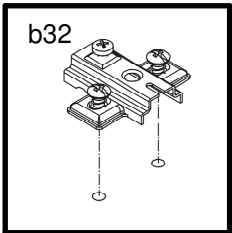
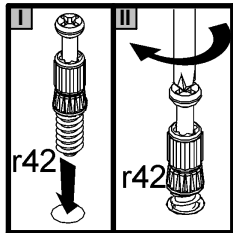
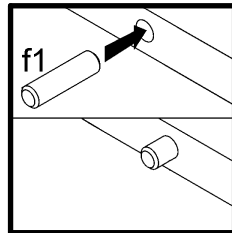
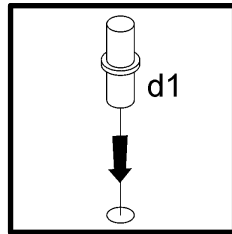
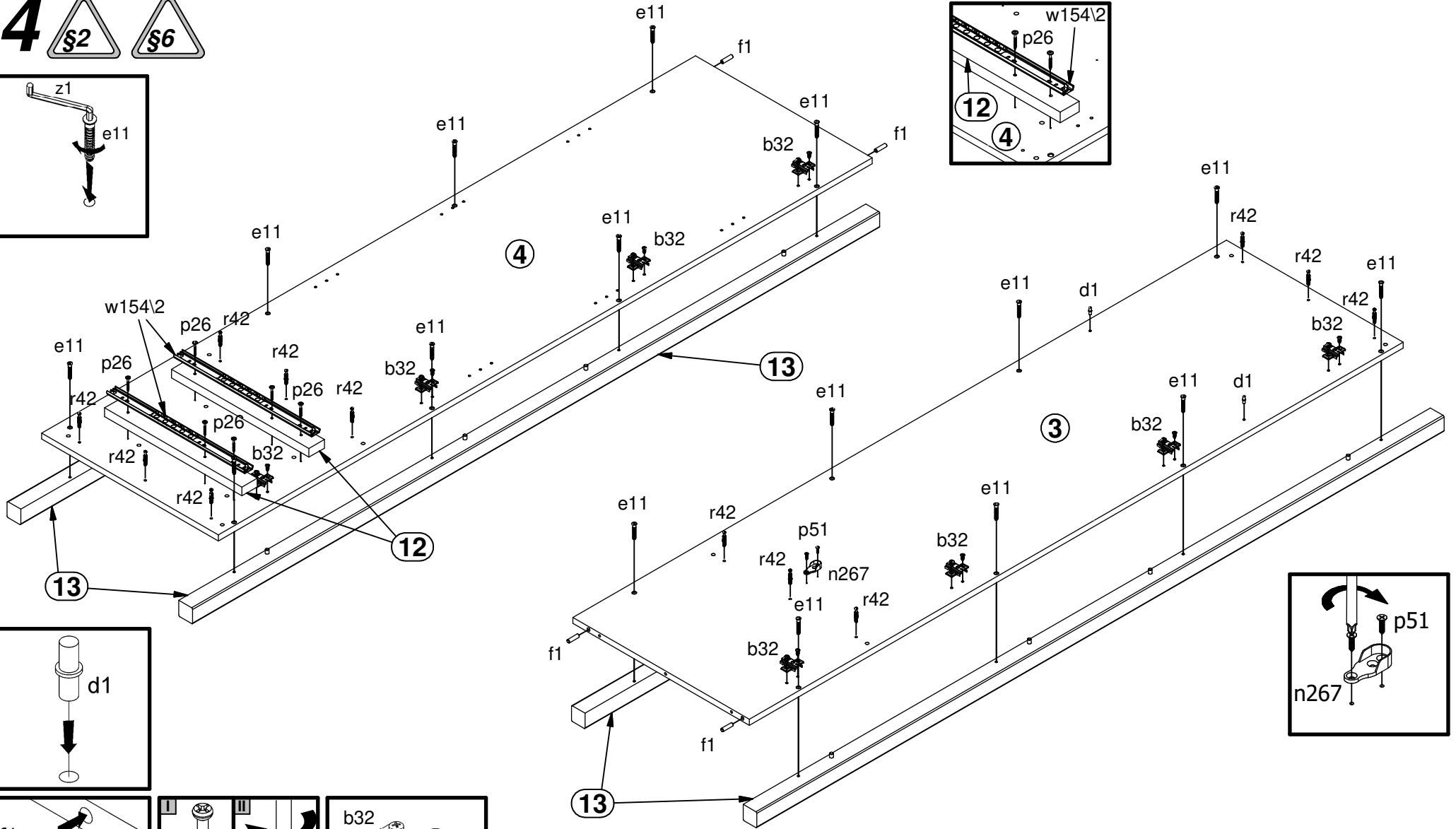
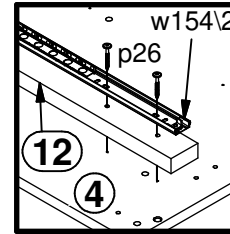
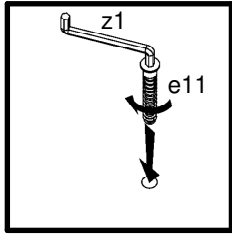

3  

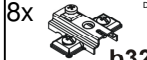
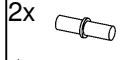

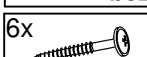
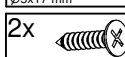
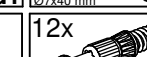

4x  b42	2x  d1 Ø5x17 mm	4x  f1 Ø8x30 mm	1x  n267
6x  p140 Ø3.5x12 mm	2x  p51 Ø3.5x15 mm	6x  r42 20/11	2x  w154/2 400/670 mm



8x  b32	2x  d1	16x  e11	4x  f1	1x  n267
6x  p26	2x  p51	12x  r42	2x  w154/2	

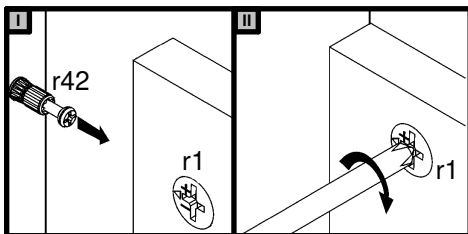
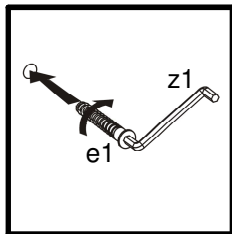
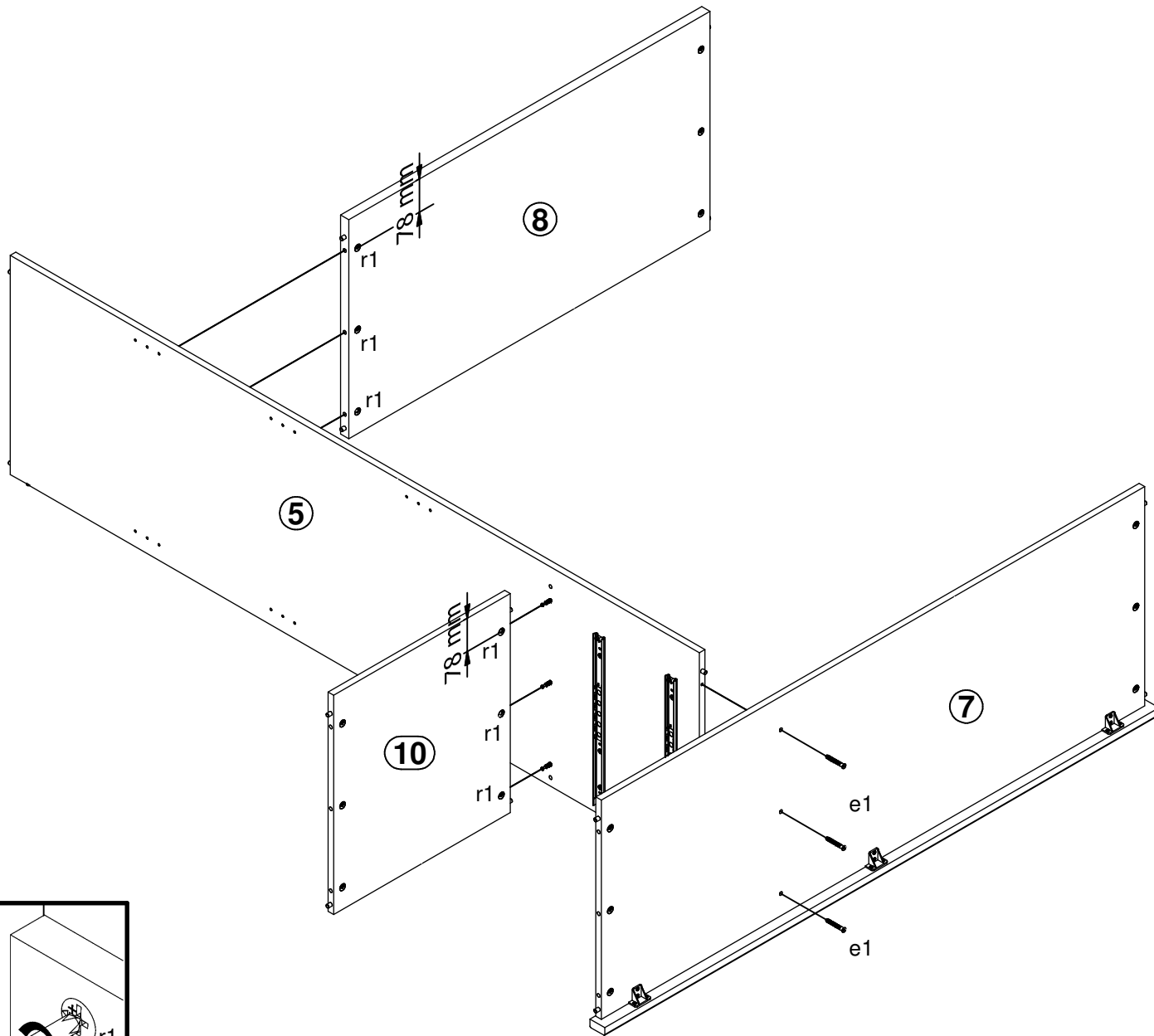

5 



3x		1x	
	Ø7x50 mm		4 mm
	e1		z1

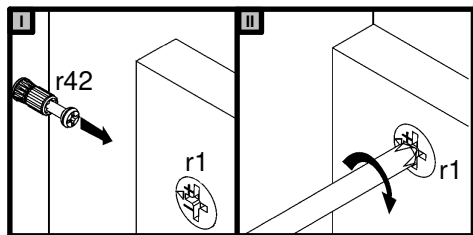
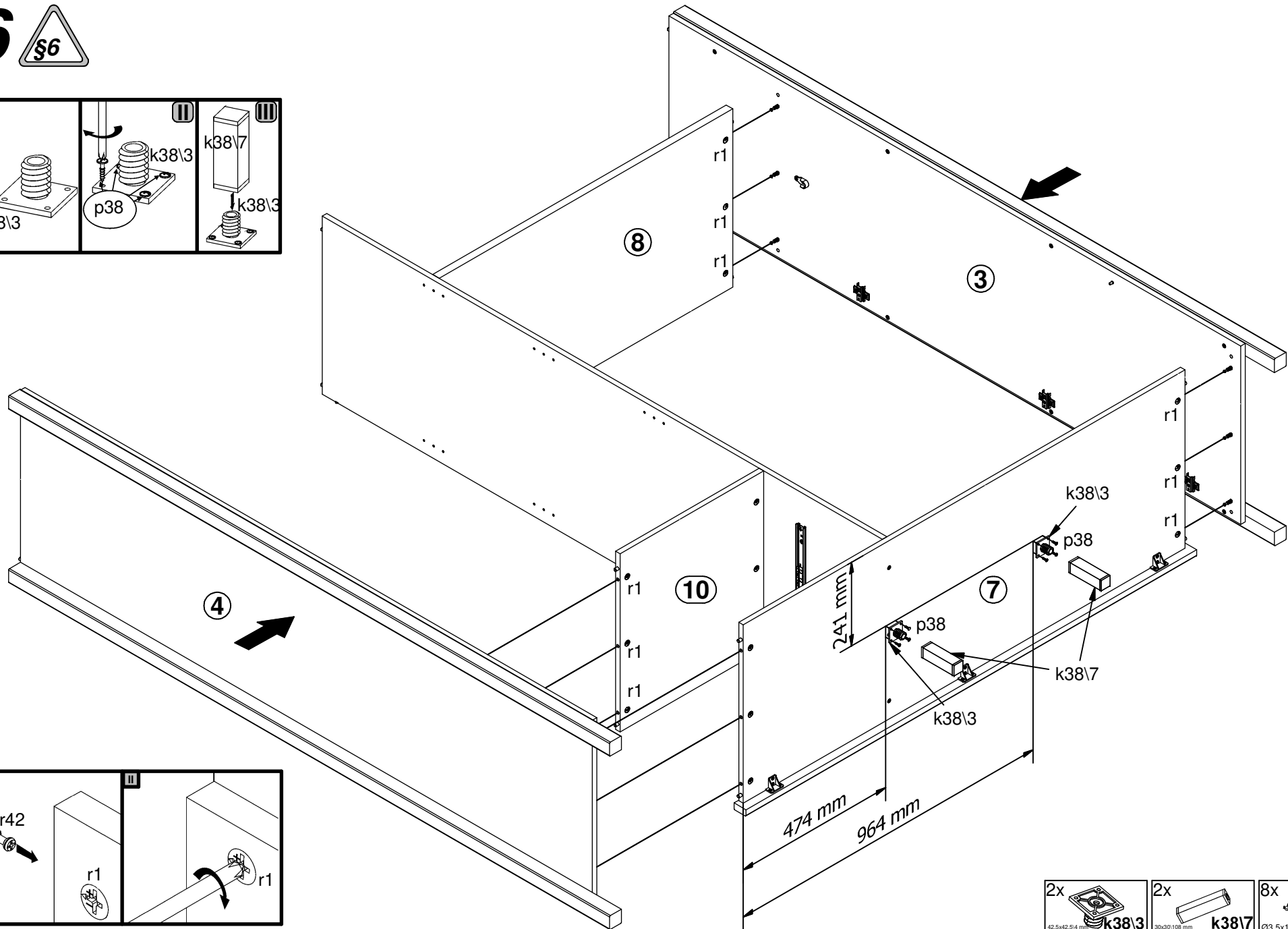
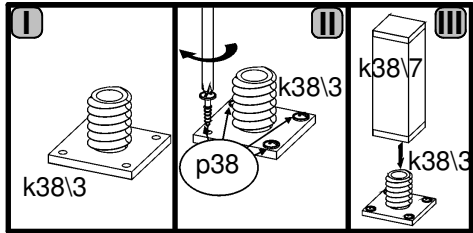

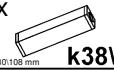
6



- 2x  k38\3 42.5x42.5x4 mm
- 2x  k38\7 30x30x108 mm
- 8x  p38 Ø3.5x16 mm

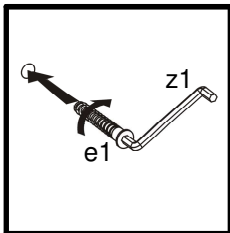
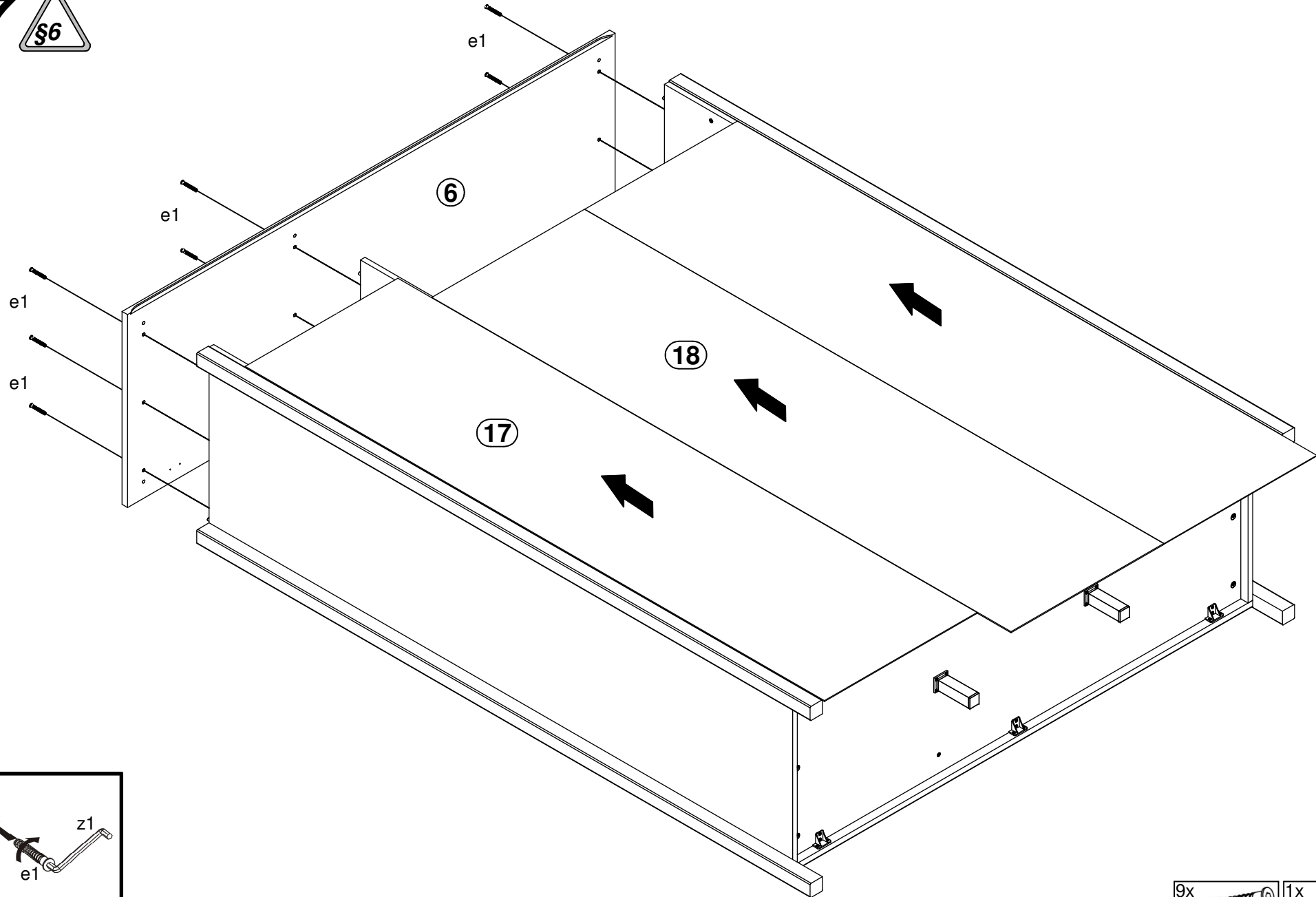

7 



9x		1x	
	Ø7x50 mm	e1	4 mm z1

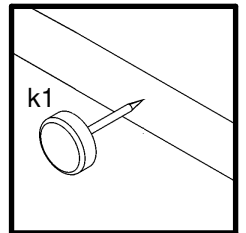
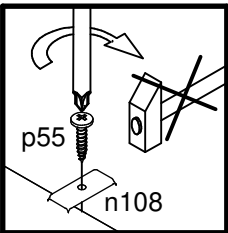
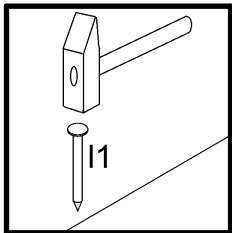
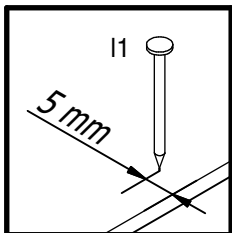
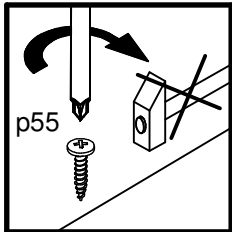
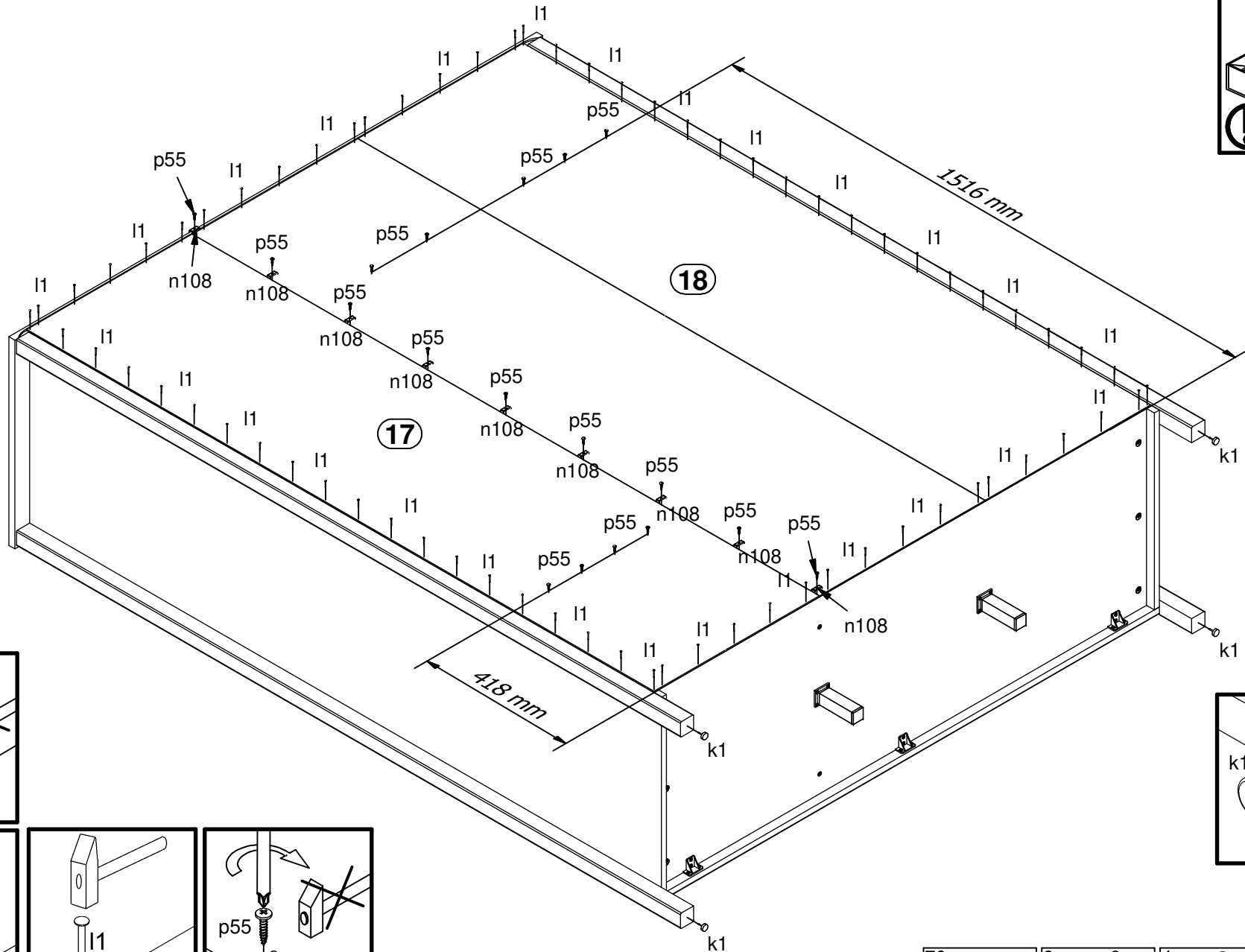
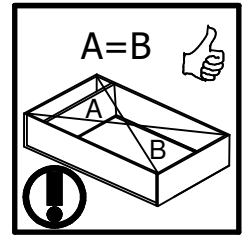

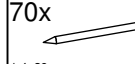
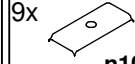
8 

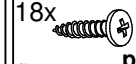

- 
70x
1,4x20 mm
l1
- 
9x
22x9,5x20,7 mm
n108
- 
4x
k1
- 
18x
Q2,9x16 mm
p55

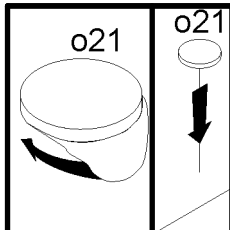
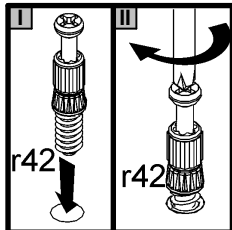
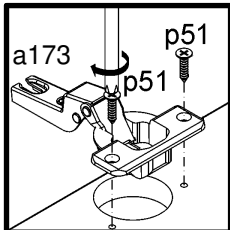
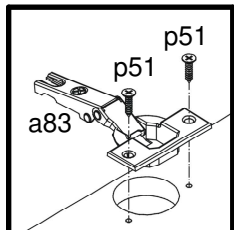
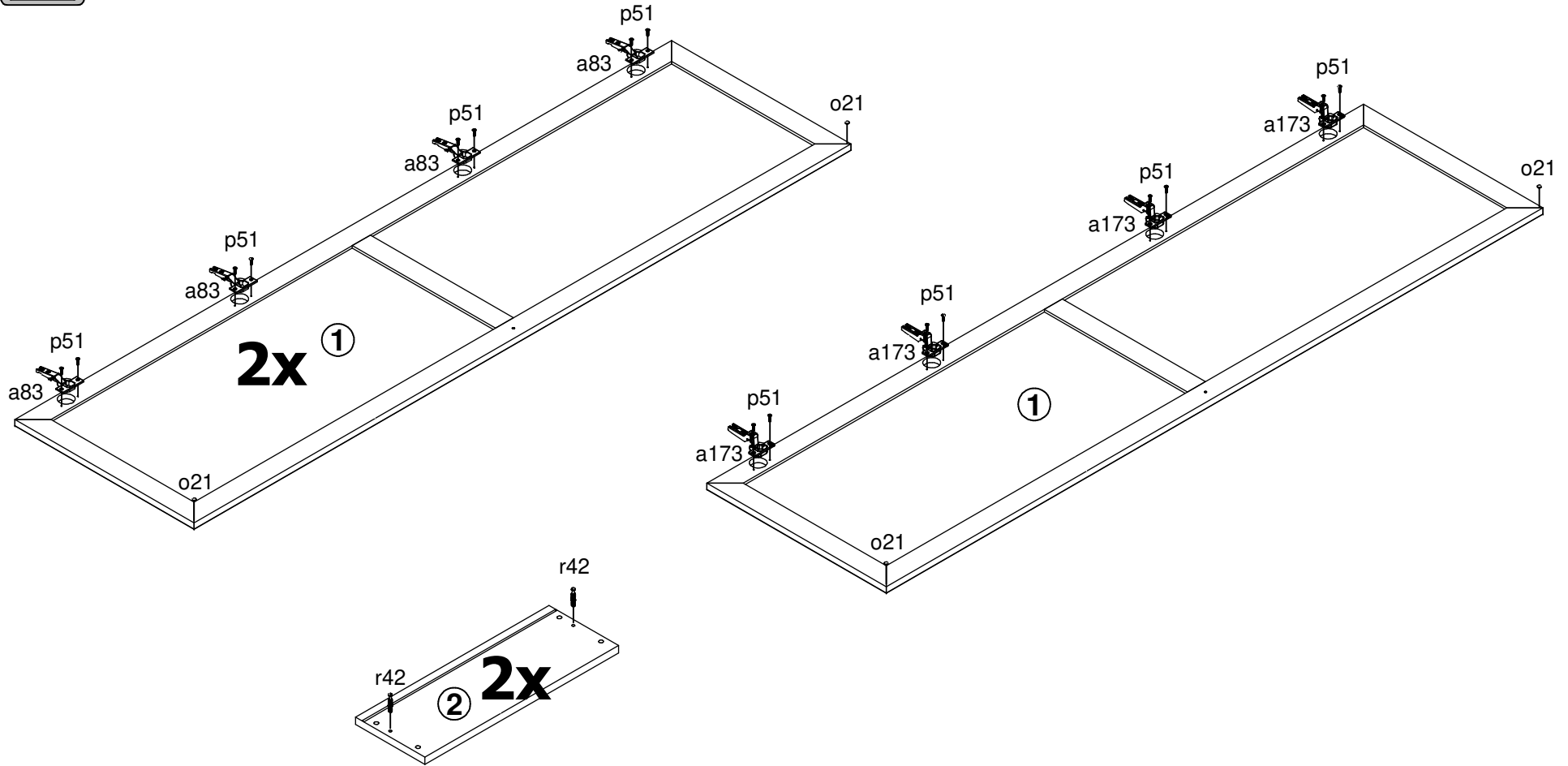
9 §6

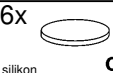
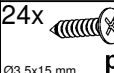
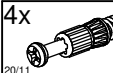

- 8x

a83
- 4x

a173
- 6x

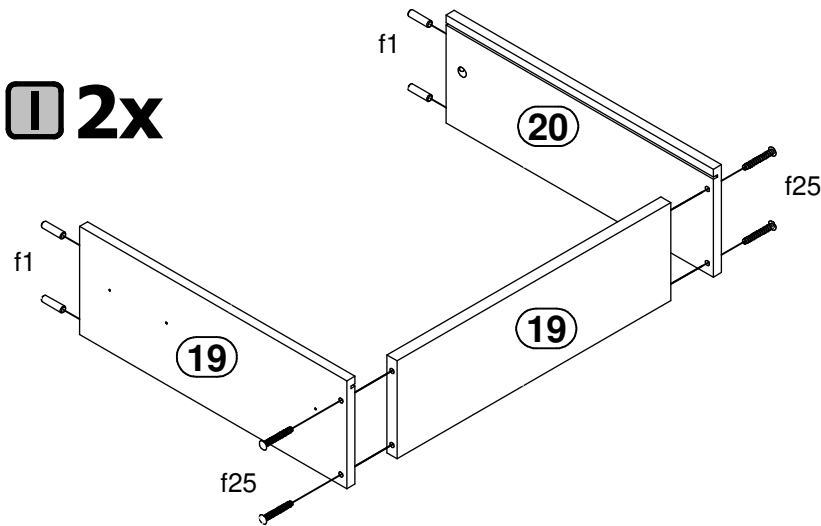
o21
- 24x

p51
Ø3.5x15 mm
- 4x

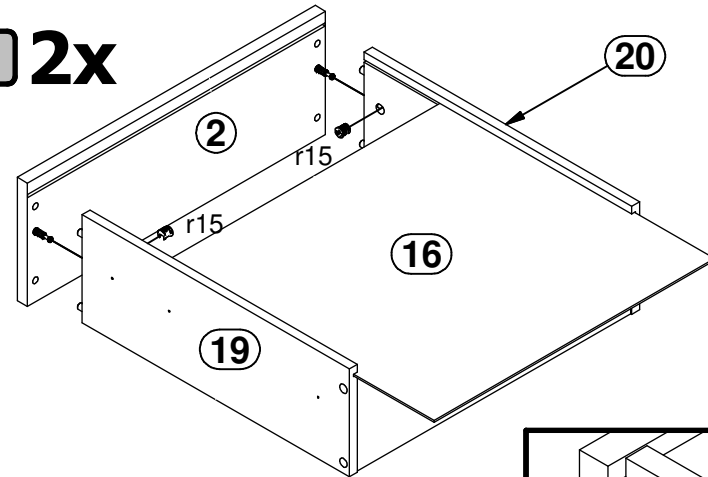
r42

10 

I 2x



II 2x





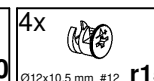
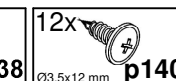
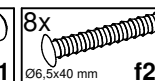
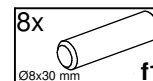
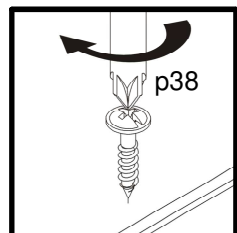
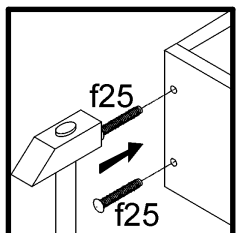
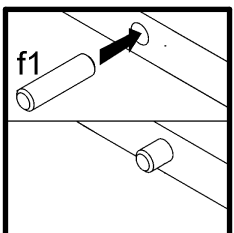
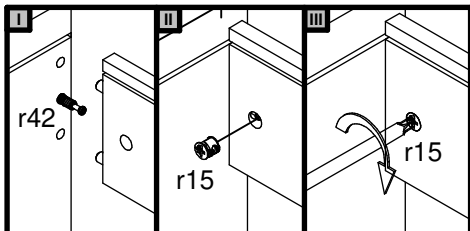
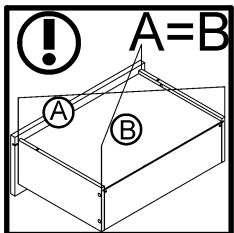
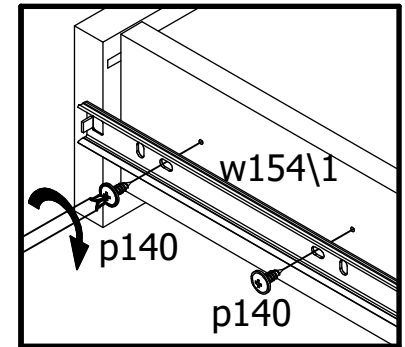
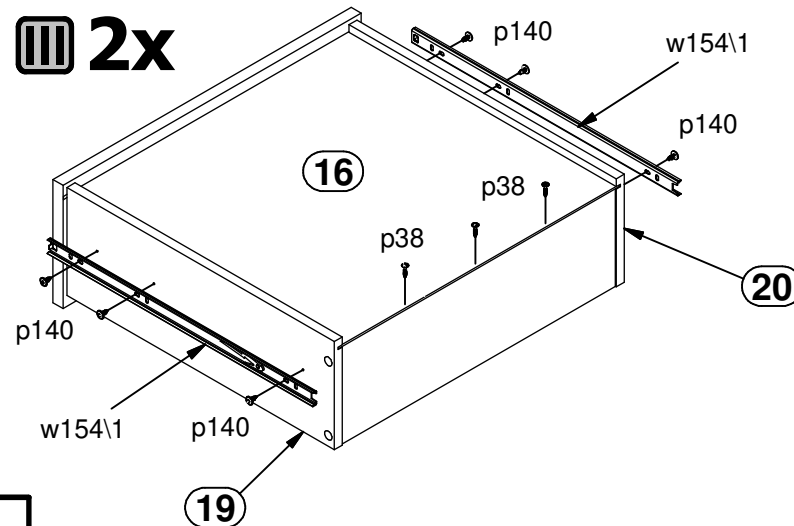



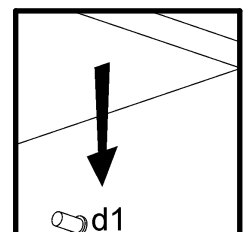
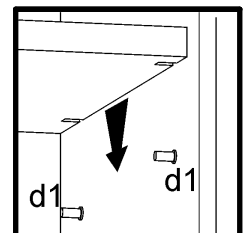
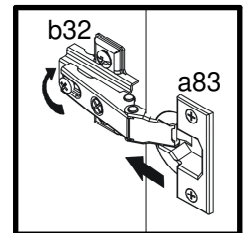
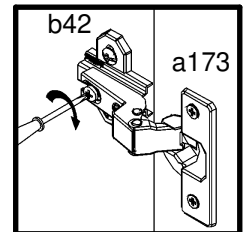
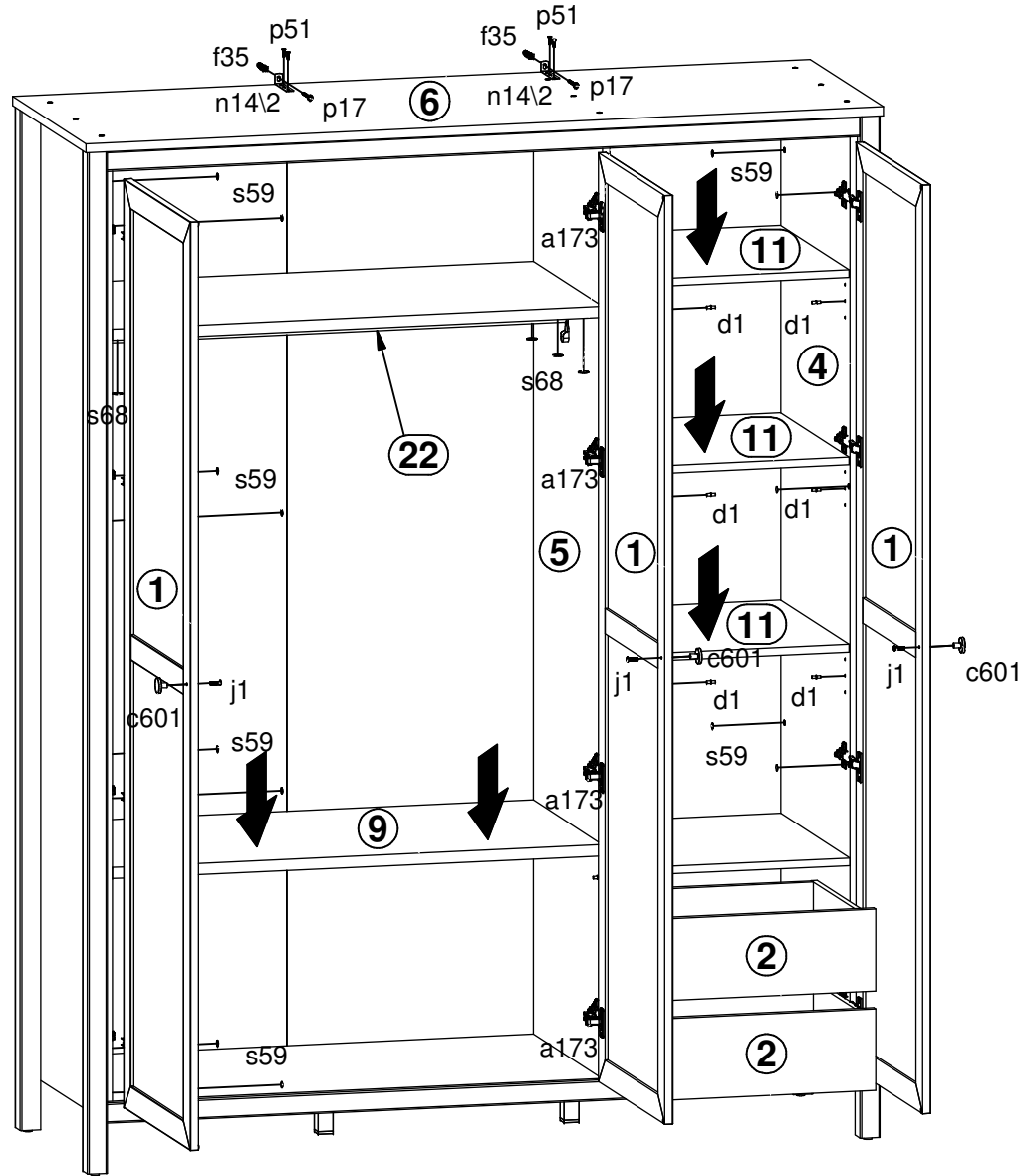
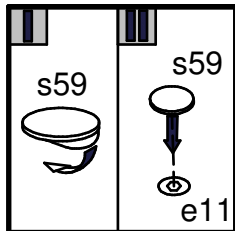
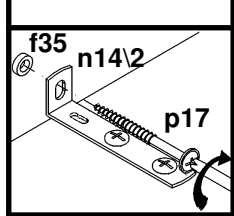
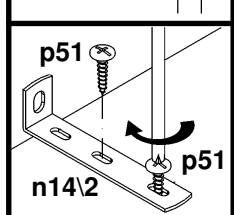
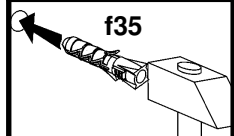
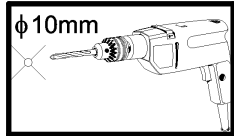
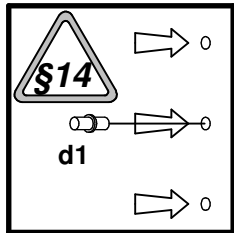
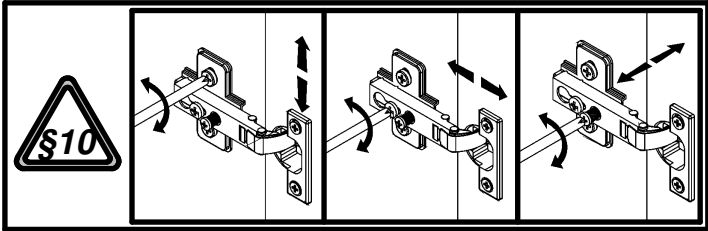

III 2x



11 



- 3x  **c601**
- 12x  **d1**
Ø5x17 mm
- 2x  **f35**
Ø10x50 mm
- 3x  **j1**
M4x20 mm
- 2x  **n14/2**
86x21x15/1.5
- 2x  **p17**
Ø5x60 mm
- 4x  **p51**
Ø3,5x15 mm
- 14x  **s59**
Ø14x0,5 mm
- 6x  **s68**
Ø 20mm

12

